

FAC

CATÁLOGO

FAC SEGURIDAD, S.A.

Garantiza sus productos de forma generalizada por un periodo de **2 AÑOS** de conformidad con la legislación vigente.

According to the current legislation, FAC SEGURIDAD S.A. guarantees its products for **2 YEARS** in general.

FAC SEGURIDAD S.A. garante, em conformidade com a legislação em vigor, os seus productos de uma forma peral, por um período de **2 ANOS**.



índice

cerrojos

LOCKING BOLTS · FERROLHOS

5

cerraduras de embutir en madera

HIGH SECURITY MORTICE LOCKS · FECHADURAS DE EMBUTIR MADEIRA

35

cerraduras de sobreponer

RIM LOCKS · FECHADURAS DE SUPERFICIE

41

cerraduras de embutir en perfil metálico

METALLIC MORTICE LOCKS · FECHADURAS PARA PORTA METÁLICA

49

cerraduras eléctricas y electrónicas

ELECTRIC LOCKS · FECHADURAS ELÉCTRICAS

55

cerraduras de garaje

GARAGE LOCKS · FECHADURAS DO GARAGE

59

cilindros de perfil europeo

EUROPROFILE CYLINDERS · CANHAOS DE PERFIL EUROPEO

63

cierrapuertas

DOOR CLOSERS · FECHA PORTAS

71

candados

PADLOCKS · CADEADOS

75

cajas fuertes de empotrar

WALL SAFES · COFRES DE EMBUTIR

87

cajas fuertes de sobreponer

FREE STANDING SAFES · COFRES SUPERFICIE

101

cajas fuertes decorativas

DECORATIVE STRONG SAFES · COFRES FORTES DECORATIVOS

115

cajas fuertes profesionales

PROFESSIONAL STRONG SAFES · COFRES FORTES PROFESSIONAIS

119

cajas ignífugas

FIREPROOF SAFES · COFRES ANTIFOGO

137

caudalitas, armarios portallaves, buzones, expositores y especiales

CASH BOXES, KEY BOXES, LETTERS BOXES AND STAND DISPLAYS
COFRES PORTÁTILES, CHAVEIROS, CAIXAS DE CORREIO E EXPOSITORES

143

especiales

SPECIAL ITEMS · ESPECIALES

151

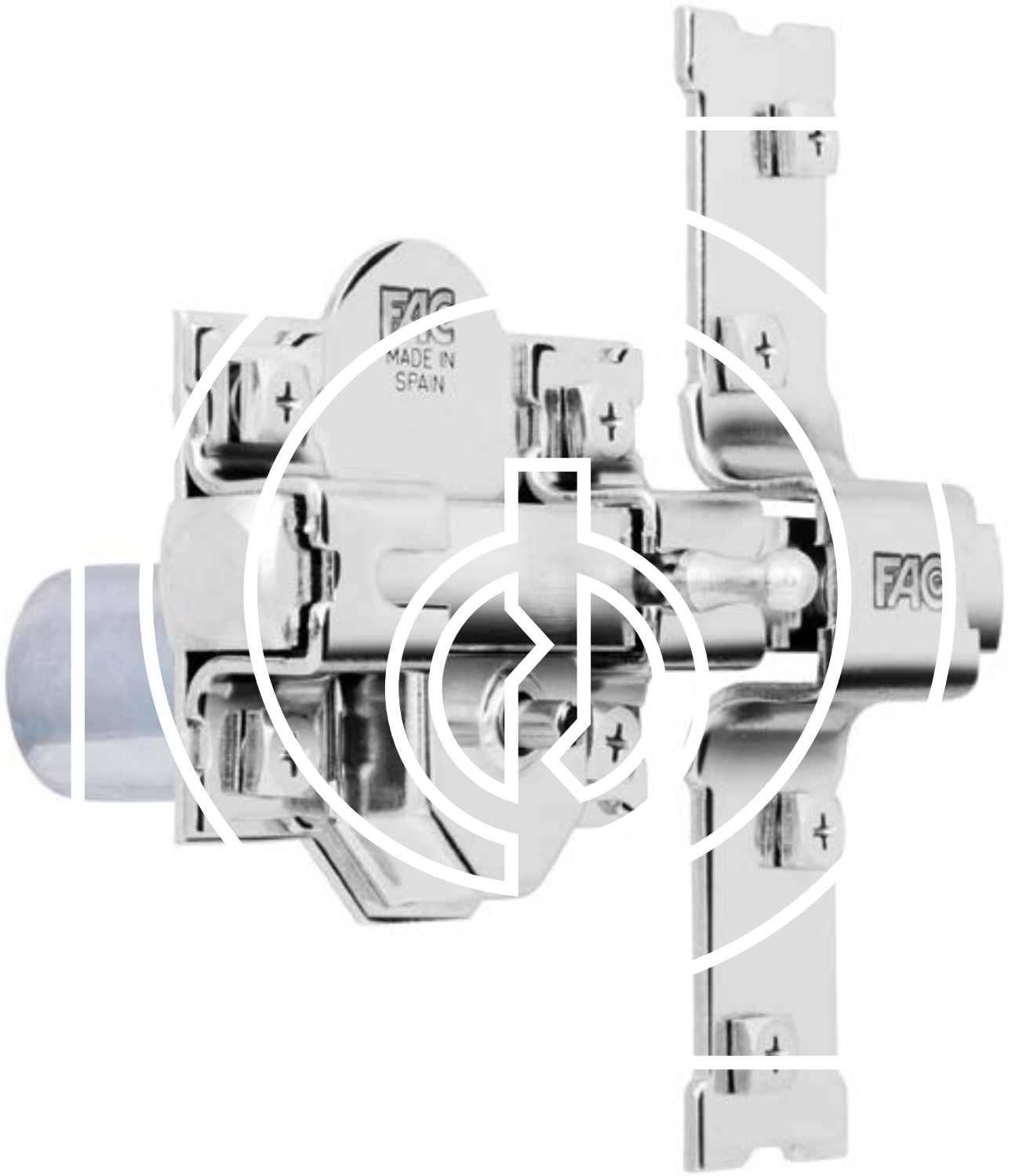



cerrojos

LOCKING BOLTS · FERROLHOS

FAC

sistemas y funciones de cerrojos

SYSTEMS AND FUNCTIONS OF LOCKING BOLTS

SISTEMAS E FUNCÕES DOS FERROLHOS

sistema R



50 R 101 RP
101 R 301 RP
201 R 301 RCP
300 R 305 RP
301 R 307 RP
305 R 308 RP
307 R 446 RP
308 R 946 RP
311 R
427 R
428 R

Se acciona por la parte interior con la mano. Para ello se oprime el botón que hay debajo de la barra, a la vez que se empuja el tirador. El exterior funciona con la llave

It's worked inside manually pushing a button and outside turning the key

São accionados pelo lado interior premindo o botão e empurrando a barra e pelo lado exterior com chave

sistema L



101 L
201 L
301 L
302 L
303 L
306 L
307 L
311 L
301 LP
946 LP
304 DF

Se acciona interior y exteriormente con llave, quedando siempre la barra fija

It's worked inside and outside turning the key

São accionados pelo lado interior e exterior con chave

sistema T



302 T
303 T
Nº 1

Por el interior se acciona con la mano, por el exterior funciona con la llave. La barra queda libre en posición de abierto y fijo en posición de cerrado

It's worked inside manually and outside with the key

São accionados pelo lado interior empurrando a barra e pelo lado exterior com chave

sistema C



91 C

Se acciona con la llave únicamente por la parte interior quedando siempre la barra fija

It's worked by a key only inside

São accionados por chave unicamente pelo lado interior ficando a barra sempre fixa C

91C / 80

SISTEMA C



Acabado pintado
 Barra en pletina de acero de 25x10 mm
 Placa en acero de 2 mm
 Cerradero en acero de 3 mm
 Cilindro de latón de 38 mm de longitud

Painted finish
 Steel bar of 25x10 mm
 2 mm steel plate
 3 mm steel striking plate
 Brass cylinder: 38 mm length

Acabamento pintado
 Barra em aço de 25x10 mm
 Placa em aço de 2 mm
 Trocador em aço de 3 mm
 Cilindro em latão de 38 mm de longitude

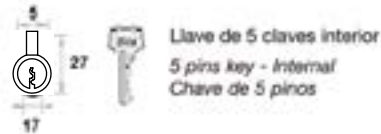
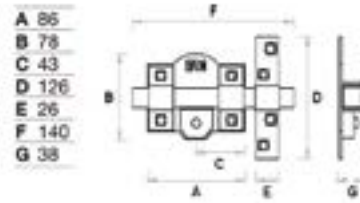

bombillo 38 mm

		Ref.	Embalaje
Pintado	(caja)	01200	12
	(blister)	01400	6

50R / 80 TRASTERO

(galvanizado)

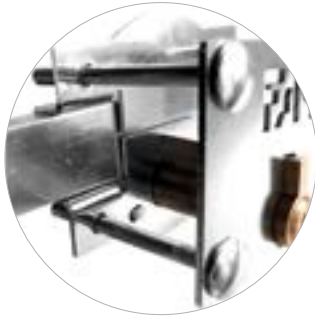

Escudo en acero galvanizado regulable para mejor anclaje



Acabado galvanizado
 Barra en pletina de acero de 25x10 mm
 Placa en acero de 2 mm
 Cerradero en acero de 3 mm
 Cilindro de latón de 50 mm de longitud

Galvanized finish
 Steel bar of 25x10 mm
 2 mm steel plate
 3 mm steel striking plate
 Brass cylinder: 50 mm length

Acabamento galvanizado
 Barra em aço de 25x10 mm
 Placa em aço de 2 mm
 Trocador em aço de 3 mm
 Cilindro em latão de 50 mm de longitude

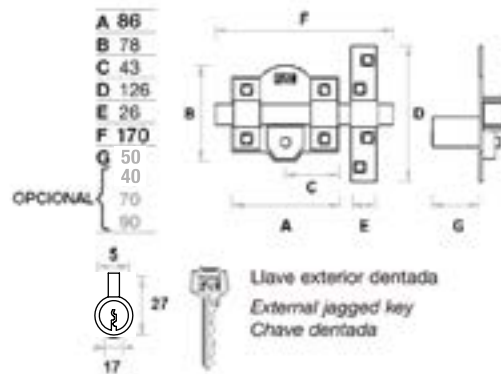

bombillo 50 mm

	Ref.	Embalaje
(caja)	01009	12
Pareja (caja)	01010	1
(blister)	01300	1

50R / 80

SISTEMA R

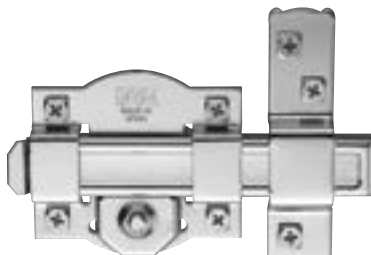

Acabado niquelado
 Barra de 10 mm en chapa de acero de 2 mm
 Placa en acero de 2 mm
 Cerradero en acero de 3 mm
 Cilindro de latón de 50-40 mm de longitud
 Para puertas de interior

Nickel plated finish
 10 mm bar in steel plate of 2 mm
 2 mm steel plate
 3 mm steel striking plate
 Brass cylinder: 50-40 mm length
 Recommended on interior doors

Acabamento niquelado
 Barra de 10 mm em aço de 2 mm
 Placa em aço de 2 mm
 Trocador em aço de 3 mm
 Cilindro em latão de 50-40 mm de longitude
 Em portas do interior

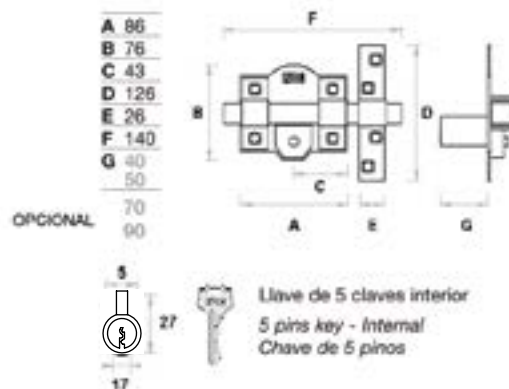

bombillo 40 mm

	Ref.	Embalaje
Niquelado (blister)	01008	12

bombillo 50 mm

	Ref.	Embalaje
Niquelado (caja)	01004	12
	(blister)	01002

101R / 105

SISTEMA R



Acabado pintado y niquelado
 Barra en acero calibrado de 18 mm
 Placa en acero de 2 mm
 Cerradero en acero de 3 mm
 Cilindro de latón de 50-70-90 mm de longitud

Painted and nickel plated finish
 18 mm steel bar
 2 mm steel plate
 3 mm steel striking plate
 Brass cylinder: 50-70-90 mm length

Acabamento pintado e niquelado
 Barra em aço de 18 mm
 Placa em aço de 2 mm
 Trocador em aço de 3 mm
 Cilindro em latão de 50-70-90mm de longitude

A 105
 B 87
 C 52
 D 150
 E 33
 F 161
 G 50
 70
 90

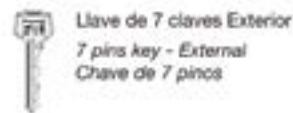
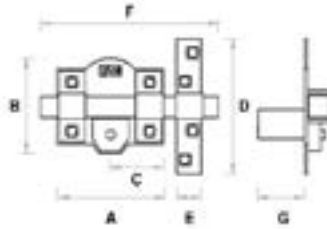

bombillo 50 mm

	Ref.	Embalaje
Pintado (caja)	01053	12
Niquelado (caja)	01054	12

bombillo 70 mm

	Ref.	Embalaje
Pintado (caja)	01559	12
Niquelado (caja)	01561	1

bombillo 90 mm

	Ref.	Embalaje
Pintado (caja)	01859	1
Niquelado (caja)	01861	1

101R / 105 GARAJE

SISTEMA R



Acabado pintado
 Barra en acero calibrado de 18 mm
 Placa en acero de 2 mm
 Cerradero en acero de 3 mm

Painted finish
 18 mm steel bar
 2 mm steel plate
 3 mm steel striking plate

Acabamento pintado
 Barra em aço de 18 mm
 Placa em aço de 2 mm
 Trocador em aço de 3 mm

bombillo 50 mm

	Ref.	Embalaje
Pintado (caja)	01056	1

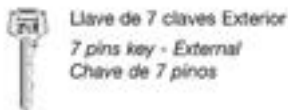

A 105
 B 87
 C 52
 D 150
 E 33
 F 500
 G 50
 70
 90

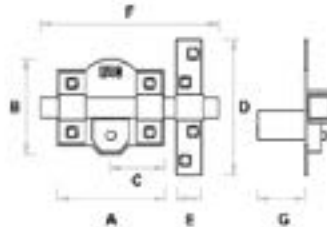

OPCIONAL

101R-L / 105 DELTA

SISTEMA R/L



Acabado pintado y niquelado
 Barra en acero calibrado de 18 mm
 Placa en acero de 2 mm
 Cerradero en acero de 3 mm

Painted and nickel plated finish
 18 mm steel bar
 2 mm steel plate
 3 mm steel striking plate

Acabamento pintado e niquelado
 Barra em aço de 18 mm
 Placa em aço de 2 mm
 Trocador em aço de 3 mm

A 105
 B 87
 C 52
 D 150
 E 33
 F 240
 G 50
 70
 90

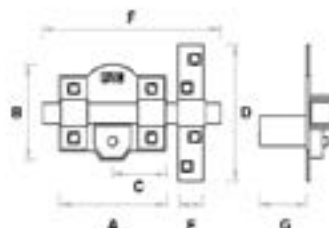

OPCIONAL

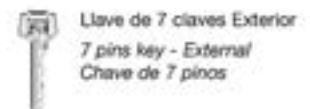

bombillo 50 mm L

	Ref.	Embalaje
Pintado (caja)	01057	12
Niquelado (caja)	01052	12

bombillo 50 mm R

	Ref.	Embalaje
Pintado (caja)	01059	12
Niquelado (caja)	01058	12

201R / 80

SISTEMA R

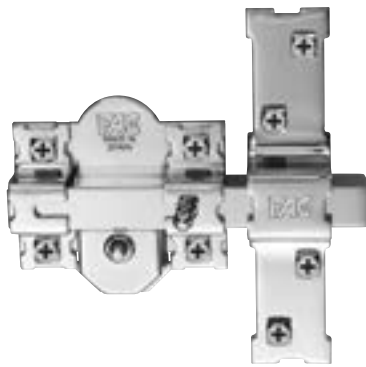

Acabado pintado, niquelado y dorado
 Barra en acero calibrado de 18 mm
 Placa en acero de 2 mm
 Cerrador en acero de 3 mm
 Cilindro de latón de 50-70 mm de longitud

Painted, nickel plated and golden finish
 18 mm steel bar
 2 mm steel plate
 3 mm steel striking plate
 Brass cylinder: 50-70 mm length

Acabamento pintado, niquelado e dourado
 Barra em aço de 18 mm
 Placa em aço de 2 mm
 Trocador em aço de 3 mm
 Cilindro em latão de 50-70 mm de longitude

A 85
 B 82
 C 42
 D 150
 E 33
 F 142
 G 50
 70
 OPCIONAL 90

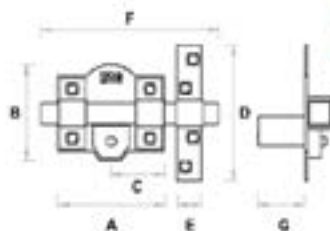

Llave de 7 clavos Exterior
 7 pins key - External
 Chave de 7 pinos

bombillo 50 mm

201R/80	Ref.	Embalaje
Pintado (caja)	01186	12
Niquelado (caja)	01187	12
Dorado (caja)	01188	12
201R G.C.M.	Ref.	Embalaje
Niquelado (caja)	01192	12
201R U.F.G.	Ref.	Embalaje
Pintado (caja)	01193	12
201R A.C.	Ref.	Embalaje
Niquelado (caja)	01194	12
201R C.V.II	Ref.	Embalaje
Pintado (caja)	01198	12

bombillo 70 mm

201R/80	Ref.	Embalaje
Pintado (caja)	01503	1
Niquelado (caja)	01504	1
Dorado (caja)	01505	1
201R G.C.M.	Ref.	Embalaje
Niquelado (caja)	01587	1
201R U.F.G.	Ref.	Embalaje
Pintado (caja)	01589	1
201R C.V.II	Ref.	Embalaje
Pintado (caja)	01580	1

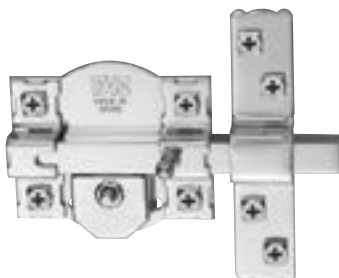

Acabado pintado, niquelado y dorado
 Barra en acero calibrado de 14 mm
 Placa en acero de 2 mm
 Cerrador en acero de 3 mm
 Cilindro de latón de 40-70-90 mm de longitud

Painted, nickel plated and golden finish
 14 mm steel bar
 2 mm steel plate
 3 mm steel striking plate
 Brass cylinder: 40-70-90 mm length

Acabamento pintado, niquelado e dourado
 Barra em aço de 14 mm
 Placa em aço de 2 mm
 Trocador em aço de 3 mm
 Cilindro em latão de 40-70-90 mm de longitude

A 87
 B 75
 C 44
 D 117
 E 26
 F 142
 G 40
 70
 90
 OPCIONAL 50

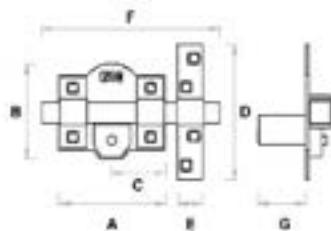

Llave de 6 clavos exterior
 6 pins key - External
 Chave de 6 pinos

300R / 80

SISTEMA R

bombillo 40 mm

	Ref.	Embalaje
Pintado (caja)	01104	12
Niquelado (caja)	01105	12
	(blister)	01305 6
Dorado (caja)	01106	1
	(blister)	01306 6

bombillo 70 mm

	Ref.	Embalaje
Pintado (caja)	01506	1
Niquelado (caja)	01507	1
Dorado (caja)	01508	1

bombillo 90 mm

	Ref.	Embalaje
Pintado (caja)	01806	1
Niquelado (caja)	01807	1
Dorado (caja)	01808	1



300R

U.E. Hidroeléctrica Aguas Cuenca

SISTEMA R

Acabado niquelado
 Barra en pletina de acero de 25x10 mm
 Placa en acero de 2 mm
 Cerradero en acero de 3 mm
 Cilindro de latón de 40-70-90 mm.de longitud

Nickel plated finish
 Steel bar of 25x10 mm
 2 mm steel plate
 3 mm steel striking plate
 Brass cylinder: 40-70-90 mm length

Acabamento niquelado
 Barra em aço de 25x10 mm
 Placa em aço de 2 mm
 Trocador em aço de 3 mm
 Cilindro em latão de 40-70-90 mm de longitude



A 85
 B 78
 C 43
 D 126
 E 26
 F 112
 G 40
 70
 90

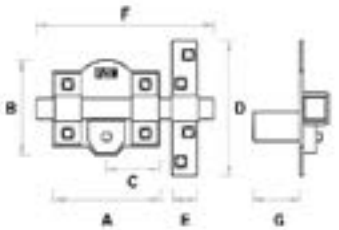

Llave exterior dentada
 External jagged key
 Chave dentada

bombillo 40 mm

300R U.E.	Ref.	Embalaje
Niquelado (dcha.)	01180	12
(izqda.)	01181	12

300R U.E. sin ACC	Ref.	Embalaje
Niquelado (dcha.)	01184	4
(izqda.)	01185	4

300R HIDRO	Ref.	Embalaje
Niquelado (dcha.)	01182	12
(izqda.)	01183	12

300R A. CUENCA	Ref.	Embalaje
Niquelado (dcha.)	01204	12
(izqda.)	01205	12

bombillo 70 mm

300R U.E.	Ref.	Embalaje
Niquelado (dcha.)	01565	1
(izqda.)	01566	1

300R HIDRO	Ref.	Embalaje
Niquelado (dcha.)	01567	1
(izqda.)	01568	1

bombillo 90 mm

300R U.E.	Ref.	Embalaje
Niquelado (dcha.)	01865	1
(izqda.)	01866	1



incluida cadena retenedora

Acabado pintado, niquelado y dorado
 Barra en acero calibrado de 18 mm
 Placa en acero de 2 mm
 Cerradero en acero de 3 mm
 Cilindro de latón de 50-70-90 mm de longitud

Painted, nickel plated and golden finish
 18 mm steel bar
 2 mm steel plate
 3 mm steel striking plate
 Brass cylinder: 50-70-90 mm length

Acabamento pintado, niquelado e dourado
 Barra em aço de 18 mm
 Placa em aço de 2 mm
 Trocador em aço de 3 mm
 Cilindro em latão de 50-70-90 mm de longitude



B 83
 C 42
 D 150
 E 33
 F 142
 G 50
 70
 90

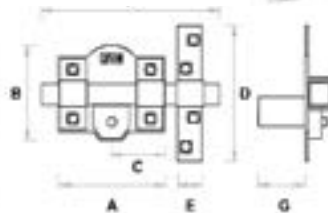

Llave de 7 claves Exterior
 7 pins key - External
 Chave de 7 pinos

301R / 80

SISTEMA R

bombillo 50 mm

	Ref.	Embalaje
Pintado (caja)	01110	12
Niquelado (caja)	01111	12
(blister)	01311	6
Dorado (caja)	01112	12
(blister)	01312	6

bombillo 70 mm

	Ref.	Embalaje
Pintado (caja)	01512	12
Niquelado (caja)	01513	12
Dorado (caja)	01514	1

bombillo 90 mm

	Ref.	Embalaje
Pintado (caja)	01812	1
Niquelado (caja)	01813	1
Dorado (caja)	01814	1

301R/120

SISTEMA R

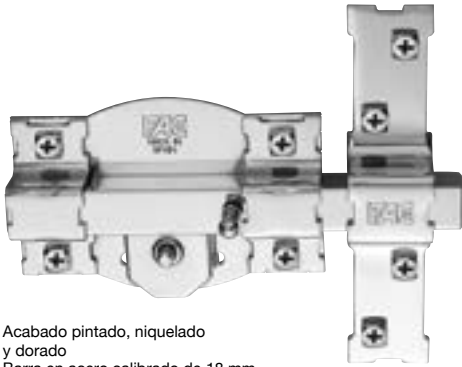

Acabado pintado, niquelado y dorado
 Barra en acero calibreado de 18 mm
 Placa en acero de 2 mm
 Cerradero en acero de 3 mm
 Cilindro de latón de 50-70-90 mm de longitud

Painted, nickel plated and golden finish
 18 mm steel bar
 2 mm steel plate
 3 mm steel striking plate
 Brass cylinder: 50-70-90 mm length

Acabamento pintado, niquelado e dourado
 Barra em aço de 18 mm
 Placa em aço de 2 mm
 Trocador em aço de 3 mm
 Cilindro em latão de 50-70-90 mm de longitude

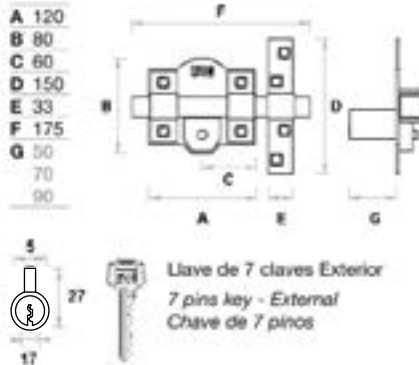

bombillo 50 mm

	Ref.	Embalaje
Pintado (caja)	01119	12
Niquelado (caja)	01120	12
Dorado (caja)	01121	1

bombillo 70 mm

	Ref.	Embalaje
Pintado (caja)	01518	1
Niquelado (caja)	01519	1
Dorado (caja)	01520	1

bombillo 90 mm

	Ref.	Embalaje
Pintado (caja)	01818	1
Niquelado (caja)	01819	1
Dorado (caja)	01820	1

13

305R/80

SISTEMA R

bombillo 50 mm		
	Ref.	Embalaje
Pintado (dcha.)	01140	1
(izqda.)	01141	1
Niquelado (dcha.)	01142	1
(izqda.)	01143	1

bombillo 70 mm		
	Ref.	Embalaje
Pintado (dcha.)	01533	1
(izqda.)	01534	1
Niquelado (dcha.)	01535	1
(izqda.)	01536	1

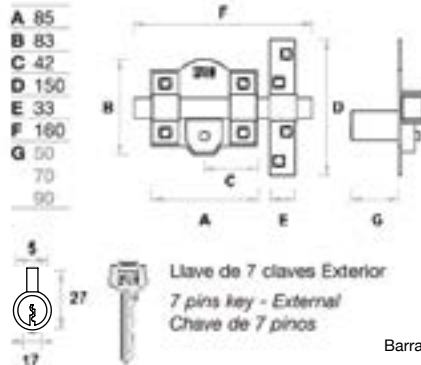

bombillo 90 mm		
	Ref.	Embalaje
Pintado (dcha.)	01833	1
(izqda.)	01834	1
Niquelado (dcha.)	01835	1
(izqda.)	01836	1

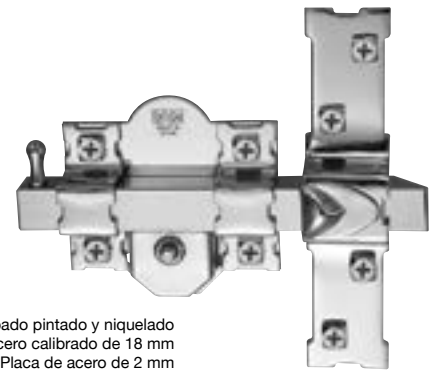

Acabado pintado y niquelado
 Barra de acero calibreado de 18 mm
 Placa de acero de 2 mm
 Cerradero en acero de 3 mm
 Cilindro de latón de 50-70-90 mm de longitud
 Sistema con efecto resbalón

Painted and nickel plated finish
 18 mm steel bar
 2 mm steel plate
 3 mm steel striking plate
 Brass cylinder: 50-70-90 mm length
 Latch system

Acabamento pintado e niquelado
 Barra em aço de 18 mm
 Placa em aço de 2 mm
 Trocador em aço de 3 mm
 Cilindro em latão de 50-70-90 mm de longitude
 Sistema com mecanismo de deslizamento



Acabado niquelado y dorado
 Barra de acero calibreado de 18 mm
 Placa de acero de 2 mm
 Cerradero en acero de 3 mm
 Cilindro de latón de 50-70-90 mm de longitud
 Cadena retenedora con eslabones de Ø 3 mm

Nickel plated and golden finish
 18 mm steel bar
 2 mm steel plate
 3 mm steel striking plate
 Brass cylinder: 50-70-90 mm length
 Ø 3 mm welded chain retainer

Acabamento niquelado e dourado
 Barra em aço de 18 mm
 Placa em aço de 2 mm
 Trocador em aço de 3 mm
 Cilindro em latão de 50-70-90 mm de longitude
 Corrente de segurança com anéis de 3 mm de espessura

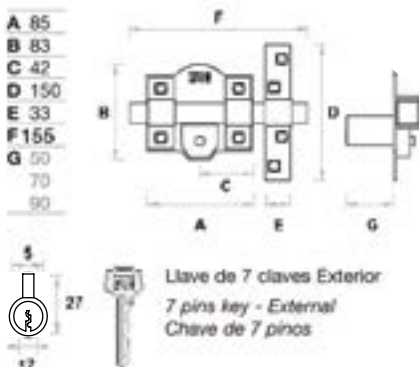

307R/80

SISTEMA R

bombillo 50 mm		
	Ref.	Embalaje
(caja) Niquelado (dcha.)	01156	12
(izqda.)	01157	12
(blister) Niquelado (dcha.)	01356	6
(izqda.)	01357	6

(caja) Dorado (dcha.)	01158	12
(izqda.)	01159	12
(blister) Dorado (dcha.)	01358	6
(izqda.)	01359	6

bombillo 70 mm

	Ref.	Embalaje
Niquelado (dcha.)	01545	1
(izqda.)	01546	1
Dorado (dcha.)	01547	1
(izqda.)	01548	1

bombillo 90 mm

	Ref.	Embalaje
Niquelado (dcha.)	01845	1
(izqda.)	01846	1
Dorado (dcha.)	01847	1
(izqda.)	01848	1

308R/80

SISTEMA R

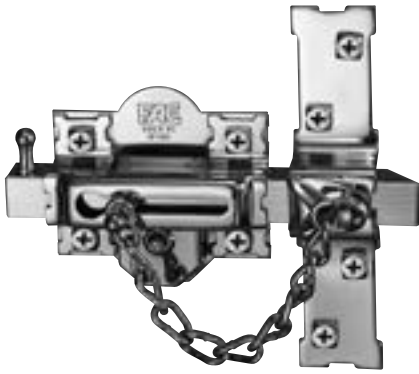

Acabado níquelado y dorado
 Barra de acero calibrado de 18 mm
 Placa de acero de 2 mm
 Cerradero en acero de 3 mm
 Cilindro de latón de 50-70-90 mm de longitud
 Cadena retenedora con eslabones de Ø 3 mm

Nickel plated and golden finish
 18 mm steel bar
 2 mm steel plate
 3 mm steel striking plate
 Brass cylinder: 50-70-90 mm length
 Ø 3 mm. welded chain retainer

Acabamento níquelado e dourado
 Barra em aço de 18 mm
 Placa em aço de 2 mm
 Trocador em aço de 3 mm
 Cilindro em latão de 50-70-90 mm de longitud
 Corrente de segurança com anéis de 3 mm de espessura

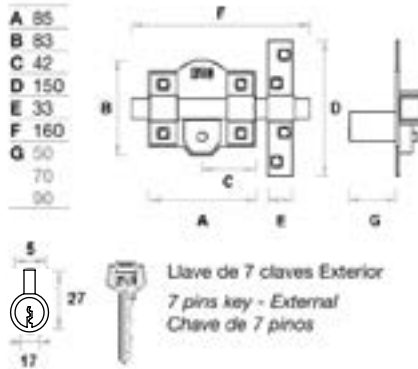

bombillo 50 mm

	Ref.	Embalaje
Níquelado (dcha.)	01164	1
(izqda.)	01165	1
Dorado (dcha.)	01166	1
(izqda.)	01167	1

bombillo 70 mm

	Ref.	Embalaje
Níquelado (dcha.)	01549	1
(izqda.)	01550	1
Dorado (dcha.)	01551	1
(izqda.)	01552	1

bombillo 90 mm

	Ref.	Embalaje
Níquelado (dcha.)	01849	1
(izqda.)	01850	1
Dorado (dcha.)	01851	1
(izqda.)	01852	1

311R/80 classic

SISTEMA R



C/C (con cilindro) S/C (sin cilindro)

Acabado níquelado y pintado dorado, blanco y marrón
 Barra de acero de 18 x 15 mm
 Placa de acero de 2 mm
 Cerradero en acero de 3 mm
 Cilindro de perfil europeo de 55 x 10 mm de longitud

Nickel plated and golden, white and brown painted finish
 18 x 15 mm steel bar
 2 mm steel plate
 3 mm steel striking plate
 Brass cylinder: 55 x 10 mm length

Acabamento níquelado e pintado de ouro, branco e marrom
 Barra em aço de 18 x 15 mm
 Placa em aço de 2 mm
 Trocador em aço de 3 mm
 Cilindro em latão de 55 x 10 mm de longitud

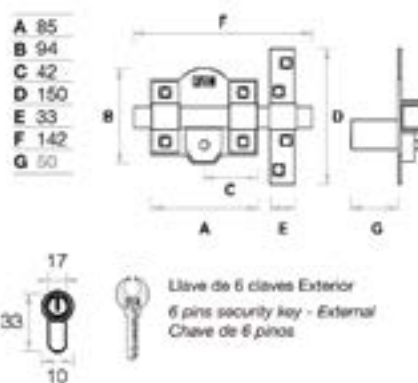

bombillo 55 x 10 mm

	Ref.	Embalaje
Níquelado C/C	01620	1
Plata C/C	01621	1
Blanco C/C	01622	1
Marrón C/C	01623	1
Dorado C/C	01624	1
Cromo Sat. C/C	01625	1

Níquelado S/C	01630	1
Plata S/C	01631	1
Blanco S/C	01632	1
Marrón S/C	01633	1
Dorado S/C	01634	1
Cromo Sat. S/C	01635	1

Accesorio escudo	01699	1
------------------	-------	---

427R/65

SISTEMA R

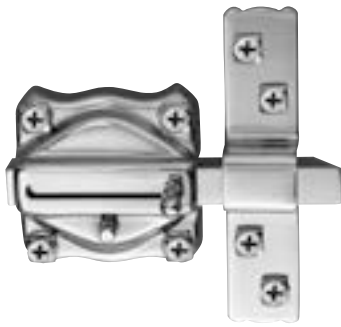

Acabado niquelado
 Barra de acero calibrado de 14 mm
 Placa de acero de 1,5 mm
 Cerradero en acero de 3 mm
 Cilindro de latón de 40-70-90 mm de longitud
 Sistema de efecto resbalón

Nickel plated finish
 14 mm steel bar
 1,5 mm steel plate
 3 mm steel striking plate
 Brass cylinder: 40-70-90 mm length
 Latch system

Acabamento niquelado
 Barra em aço de 14 mm
 Placa em aço de 1,5 mm
 Trocador em aço de 3 mm
 Cilindro em latão de 40-70-90 mm de longitudude
 Sistema con mecanismo de deslizamiento



bombillo 40 mm		
	Ref.	Embalaje
Niquelado (dcha.)	01174	1
(izqda.)	01175	1
bombillo 70 mm		
	Ref.	Embalaje
Niquelado (dcha.)	01553	1
(izqda.)	01554	1
bombillo 90 mm		
	Ref.	Embalaje
Niquelado (dcha.)	01853	1
(izqda.)	01854	1

15

428R/65

SISTEMA R

bombillo 40 mm		
	Ref.	Embalaje
Niquelado (caja)	01177	1
bombillo 70 mm		
	Ref.	Embalaje
Niquelado (caja)	01556	1
bombillo 90 mm		
	Ref.	Embalaje
Niquelado (caja)	01856	1

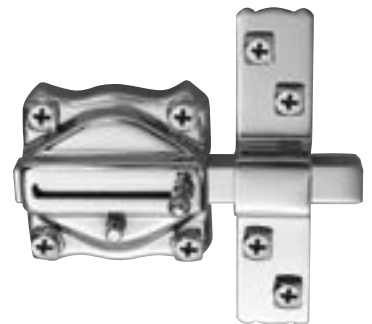
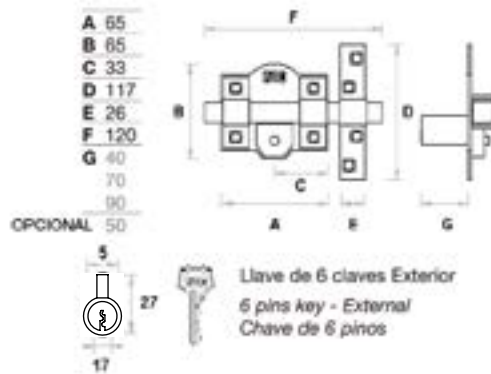

Acabado niquelado
 Barra de acero calibrado de 14 mm
 Placa de acero de 1,5 mm
 Cerradero en acero de 3 mm
 Cilindro de latón de 40-70-90 mm de longitud

Nickel plated finish
 14 mm steel bar
 1,5 mm steel plate
 3 mm steel striking plate
 Brass cylinder: 40-70-90 mm length

Acabamento niquelado
 Barra em aço de 14 mm
 Placa em aço de 1,5 mm
 Trocador em aço de 3 mm
 Cilindro em latão de 40-70-90 mm de longitudude



Acabado pintado y niquelado
 Barra de acero calibrado de 18 mm
 Placa de acero de 2 mm
 Cerradero en acero de 3 mm
 Cilindro de latón de 50 mm de longitud

Painted and nickel plated finish
 18 mm steel bar
 2 mm steel plate
 3 mm steel striking plate
 Brass cylinder: 50 mm length

Acabamento pintado e niquelado
 Barra em aço de 18 mm
 Placa em aço de 2 mm
 Trocador em aço de 3 mm
 Cilindro em latão de 50 mm de longitudude

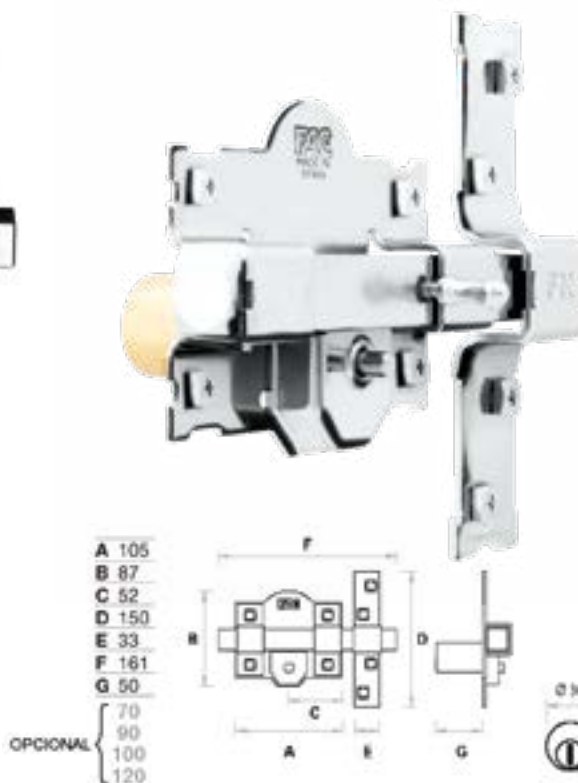

101RP/105

SISTEMA R

bombillo 50 mm		
	Ref.	Embalaje
Niquelado (caja)	01064	1
Pintado (caja)	01063	1

301RP/80-RCP/80

SISTEMA R

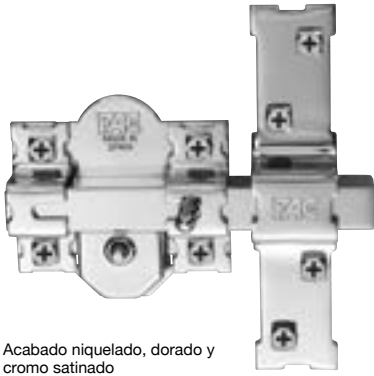

Acabado niquelado, dorado y cromo satinado
Barra de acero calibrado de 18 mm
Placa de acero de 2 mm
Cerradero en acero de 3 mm
Cilindro de latón de 50-70-90-100-120 mm de longitud

Nickel plated, golden and satin chromed finish
18 mm steel bar
2 mm steel plate
3 mm steel striking plate
Brass cylinder:
50-70-90-100-120 mm length

Acabamento niquelado, dourado e níquel acetinado
Barra em aço de 18 mm
Placa em aço de 2 mm
Trocaador em aço de 3 mm
Cilindro em latão de 50-70-90-100-120 mm de longitude

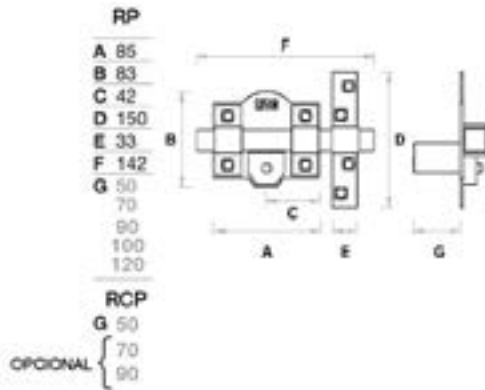

RCP



RP



Llave de 6 claves Exterior
6 pins security key - External
Chave de 6 pinos

incluida cadena retenedora

bombillo 50 mm

	Ref.	Embalaje
Niquelado (caja)	01114	12
(blister)	01314	6
Dorado (caja)	01115	12
(blister)	01315	6
Cromo sat. (caja)	01113	1
Niq. comp. (caja)	01100	1
RCP Niq. (caja)	01101	1
RCP Dor. (caja)	01102	1

bombillo 70 mm

	Ref.	Embalaje
Niq. comp. (caja)	01569	1
Niquelado (caja)	01570	1
Dorado (caja)	01571	1

bombillo 90 mm

	Ref.	Embalaje
Niquelado (caja)	01870	1
Dorado (caja)	01871	1

bombillo 100 mm

	Ref.	Embalaje
Niquelado (caja)	01951	1
Dorado (caja)	01952	1

bombillo 120 mm

	Ref.	Embalaje
Niquelado (caja)	01961	1
Dorado (caja)	01962	1

301RP/80

SISTEMA R

especial PUERTA BLINDADA

bombillo 50 mm

	Ref.	Emb
Niquelado (caja)	01096	1
Dorado (caja)	01097	1

Acabado niquelado y dorado
Barra en acero calibrado de 18 mm
Placa en acero de 2 mm
Cerrador en acero de 3 mm
Cilindro de latón de 50 mm de longitud

Nickel plated and golden finish
18 mm steel bar
2 mm steel plate
3 mm steel striking plate
Brass cylinder: 50 mm length

Acabamento niquelado e dourado
Barra em aço de 18 mm
Placa em aço de 2 mm
Trocaador em aço de 3 mm
Cilindro em latão de 50 mm de longitude

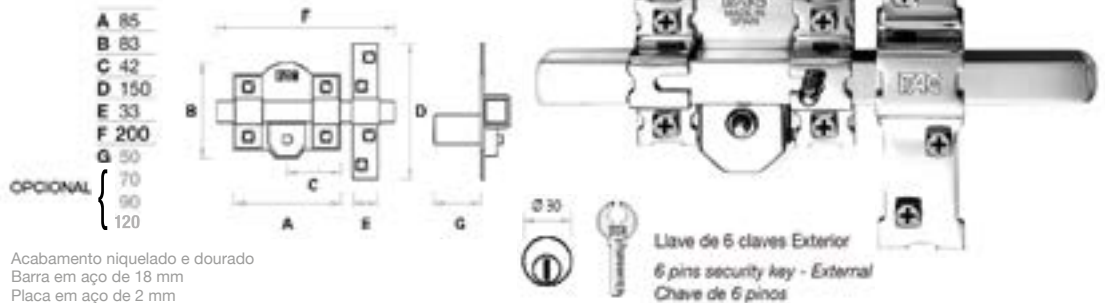

Acabado niquelado
Barra en acero calibrado de 18 mm
Placa de acero de 2 mm
Cerradero de 3 mm
Sin tirador y caja ciega (no apertura desde interior)

Escudo exterior en acero cromado en negro
Cilindro de latón de 50-70-90-100-120 mm

Nickel finish
18 mm steel bar
2 mm steel plate
3 mm steel strike plate
No handle (it can't be operated from inside)
Escutcheon made from steel in black color
Brass cylinder: 50-70-90-100-120 mm

Acabamento niquelado
Barra em aço de 18 mm
Placa em aço de 2 mm
Trancador em aço de 3 mm
Sem puxador e entrada do cilindro (não abre desde o interior)
Espelho exterior em aço cromado preto
Cilindro de latão de 50-70-90-100-120 mm

301RP/80 TRANSPORT

especial furgonetas



bombillo 50 mm

	Ref.	Embalaje
Niquelado (caja)	01098	1

bombillo 70 mm

	Ref.	Embalaje
Niquelado (caja)	01598	1

bombillo 90 mm

	Ref.	Embalaje
Niquelado (caja)	01898	1

bombillo 100 mm

	Ref.	Embalaje
Niquelado (caja)	01950	1

bombillo 120 mm

	Ref.	Embalaje
Niquelado (caja)	01960	1



305RP/80

SISTEMA R

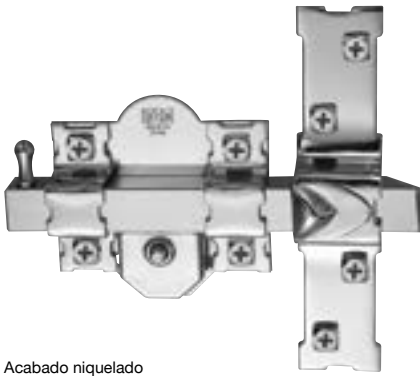

Acabado niquelado
Barra de acero calibrado de 18 mm
Placa de acero de 2 mm
Cerradero en acero de 3 mm
Cilindro de latón de 50 mm de longitud

Sistema con efecto resbalón

Nickel plated finish
18 mm steel bar
2 mm steel plate
3 mm steel striking plate
Brass cylinder: 50 mm length
Latch system

Acabamento niquelado
Barra em aço de 18 mm
Placa em aço de 2 mm
Trocaador em aço de 3 mm
Cilindro em latão de 50 mm de longitudude
Sistema com mecanismo de deslizamento

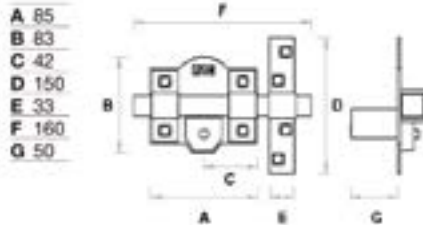

A 85
B 83
C 42
D 150
E 33
F 160
G 50



Llave de 6 claves Exterior
6 pins security key - External
Chave de 6 pinos

bombillo 50 mm

	Ref.	Embalaje
Niquelado (dcha.)	01146	1
(izqda.)	01147	1

17

307RP/80

SISTEMA R

bombillo 50 mm

	Ref.	Embalaje
(caja) Niquelado (dcha.)	01160	1
(izqda.)	01161	1
(blister) Niquelado (dcha.)	01360	6
(izqda.)	01361	6
(caja) Dorado (dcha.)	01162	1
(izqda.)	01163	1

bombillo 70 mm

	Ref.	Embalaje
Niquelado (dcha.)	01572	1
(izqda.)	01573	1
Dorado (dcha.)	01574	1
(izqda.)	01575	1

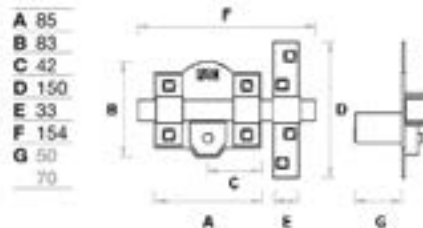

A 85
B 83
C 42
D 150
E 33
F 154
G 50
70



Llave de 6 claves Exterior
6 pins security key - External
Chave de 6 pinos

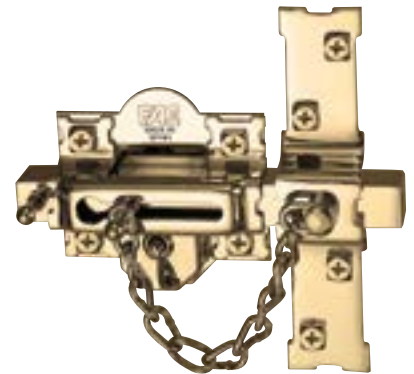

Acabado niquelado y dorado
Barra de acero calibrado de 18 mm
Placa de acero de 2 mm
Cerradero en acero de 3 mm
Cilindro de latón de 50-70 mm de longitud
Cadena retenedora con eslabones de Ø 3 mm

Nickel plated and golden finish
18 mm steel bar
2 mm steel plate
3 mm steel striking plate
Brass cylinder: 50-70 mm length
Ø 3 mm welded chain retainer

Acabamento niquelado e dourado
Barra em aço de 18 mm
Placa em aço de 2 mm
Trocaador em aço de 3 mm
Cilindro em latão de 50-70 mm de longitudude
Corrente de segurança com anéis de 3 mm de espessura

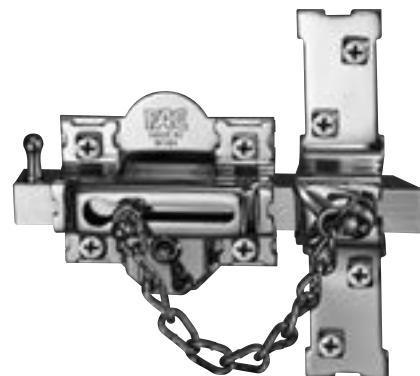

Acabado niquelado y dorado
Barra de acero calibrado de 18 mm
Placa de acero de 2 mm
Cerradero en acero de 3 mm
Cilindro de latón de 50-70 mm de longitud
Cadena retenedora con eslabones de Ø 3 mm

Nickel plated and golden finish
18 mm steel bar
2 mm steel plate
3 mm steel striking plate
Brass cylinder: 50-70 mm length
Ø 3 mm welded chain retainer

Acabamento niquelado e dourado
Barra em aço de 18 mm
Placa em aço de 2 mm
Trocaador em aço de 3 mm
Cilindro em latão de 50-70 mm de longitudude
Corrente de segurança com anéis de 3 mm de espessura

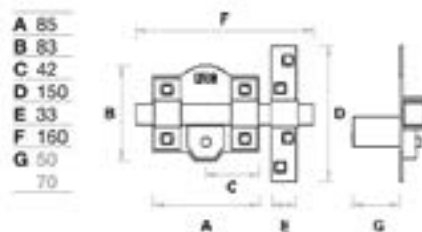

A 85
B 83
C 42
D 150
E 33
F 160
G 50
70



Llave de 6 claves Exterior
6 pins security key - External
Chave de 6 pinos

308RP/80

SISTEMA R

bombillo 50 mm

	Ref.	Embalaje
Niquelado (dcha.)	01168	1
(izqda.)	01169	1
Dorado (dcha.)	01170	1
(izqda.)	01171	1

bombillo 70 mm

	Ref.	Embalaje
Niquelado (dcha.)	01576	1
(izqda.)	01577	1
Dorado (dcha.)	01578	1
(izqda.)	01579	1

CARCASA MAGNÉTICA INTERCAMBIABLE

(4 acabados disponibles)



446RP/80 UVE

SISTEMA R magnet

ANTI-BUMPING



ÚNICO Y PRIMER CERROJO EN ESPAÑA CON CERTIFICACIÓN UNE-EN 1303



cerrojo UVE magnet 50mm

	Ref.	Embalaje
Níquel (caja)	01920	1
Dorado (caja)	01921	1
Satinado (caja)	01922	1
Blanco (caja)	01923	1

cerrojo UVE magnet 70mm

	Ref.	Embalaje
Níquel (caja)	01930	1
Dorado (caja)	01931	1
Satinado (caja)	01932	1
Blanco (caja)	01933	1



ANTI-PALANQUETA
(nuevo cerradero solapado adicional anti-palanqueta)

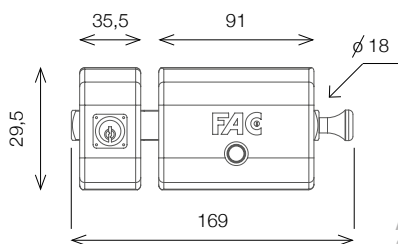

ANTI-EXTRACCIÓN
(nueva placa de sujeción del bombillo en acero)



kit carcasas

	Ref.	Embalaje
Níquel 4 unidades	99327	1
Dorado 4 unidades	99328	1
Satinado 4 unidades	99329	1
Blanco 4 unidades	99330	1
Multi 4 unidades	99331	1

suplemento instalación

	Ref.	Embalaje
Magnet 10 unidades	99332	1

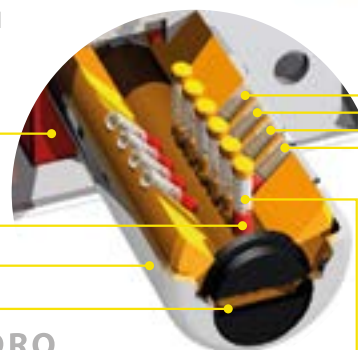

ANTI-BUMPING

(8 pitos diábolo flotantes dispuestos en nuevo sistema en V)

ANTI-TALADRO

(casquillo y disco giratorio en acero carbonitrurado primer pito en acero inoxidable)

ANTI-GANZÚA

(pitos diábolo alternos y pitos diábolo flotantes dispuestos en nuevo sistema en V)

946RP/80 UVE

SISTEMA R

ANTI-BUMPING

ANTI-EXTRACCIÓN
(nueva placa de sujeción del bombillo en acero)

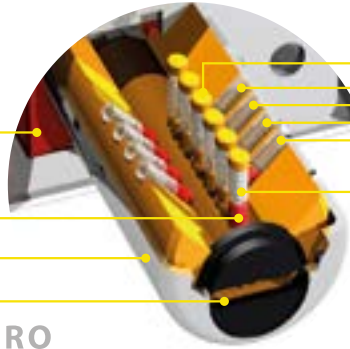

ANTI-IMPRESSIONING

ANTI-BUMPING

(8 pitos diábolo flotantes dispuestos en nuevo sistema en V)

ANTI-TALADRO

(casquillo y disco giratorio en acero carbonitrurado primer pito en acero inoxidable)

ANTI-GANZÚA

(pitos diábolo alternos y pitos diábolo flotantes dispuestos en nuevo sistema en V)

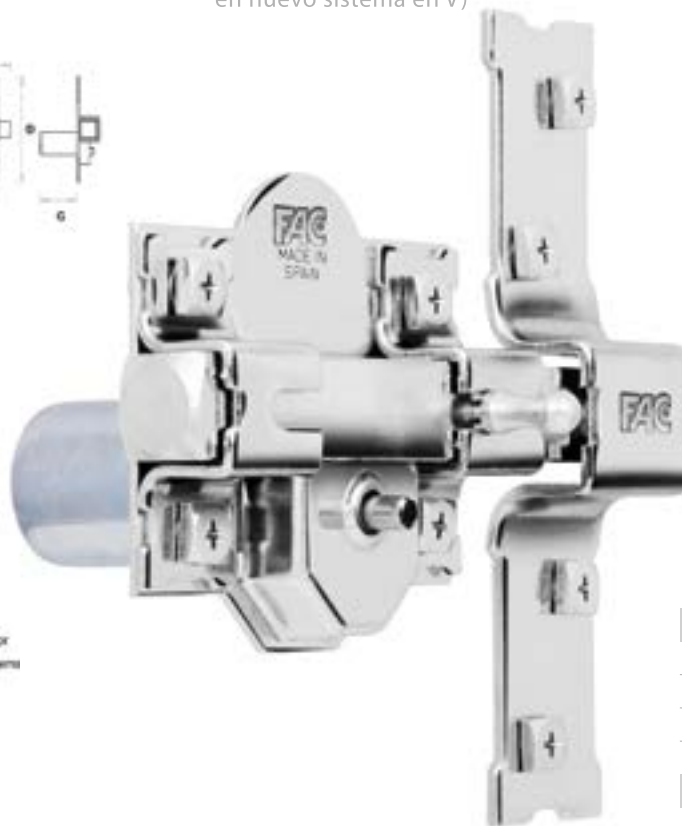
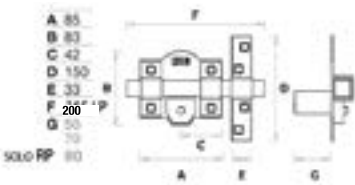

ÚNICO Y PRIMER CERROJO EN ESPAÑA CON CERTIFICACIÓN UNE-EN 1303



ANTI-PALANQUETA

(nuevo cerradero solapado adicional anti-palanqueta)

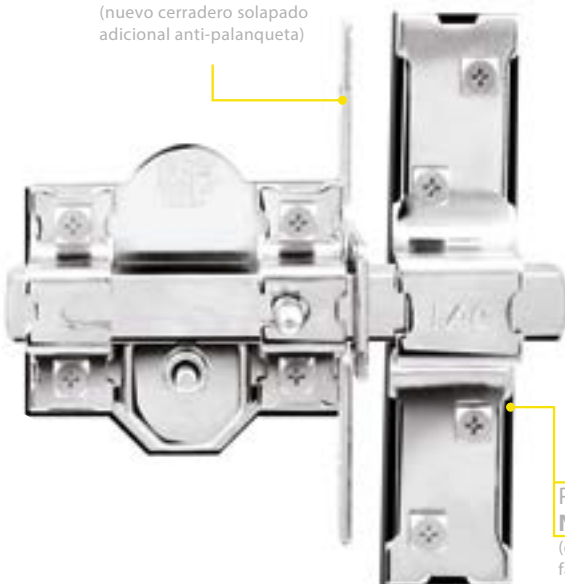

PLACA TRASERA NIVELADORA

(enrasa el cerradero y facilita su instalación con sus líneas rectas)

bombillo 50 mm

		Ref.	Embalaje
Níquel	(caja)	01090	1
Dorado	(caja)	01091	1
Cromo Sat.	(caja)	01094	1

bomb.50 mm PUERTA BLINDADA

		Ref.	Embalaje
Níquel	(caja)	01092	1
Dorado	(caja)	01093	1

bombillo 50 mm

		Ref.	Embalaje
Níquel	(blister)	01390	1
Dorado	(blister)	01391	1

bombillo 70 mm

		Ref.	Embalaje
Níquel	(caja)	01592	1
Dorado	(caja)	01593	1
Cromo Sat.	(caja)	01650	1

bomb.70 mm PUERTA BLINDADA

		Ref.	Embalaje
Níquel	(caja)	01595	1
Dorado	(caja)	01596	1

bombillo 90 mm

		Ref.	Embalaje
Níquel	(caja)	01890	1
Dorado	(caja)	01891	1

101L/105

SISTEMA L



Acabado pintado y niquelado
 Barra de acero calibrado de 18 mm
 Placa de acero de 2 mm
 Cerradero en acero de 3 mm
 Cilindro de latón de 50-70-90 mm de longitud

Painted and nickel plated finish
 18 mm steel bar.
 2 mm steel plate
 3 mm steel striking plate
 Brass cylinder: 50-70-90 mm length

Acabamento pintado e niquelado
 Barra em aço de 18 mm
 Placa em aço de 2 mm
 Trocador em aço de 3 mm
 Cilindro em latão de 50-70-90 mm de longitude

A 105
 B 87
 C 52
 D 150
 E 33
 F 183
 G 50
 70
 90

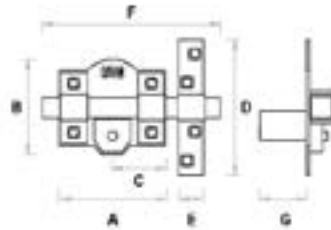

Llave de 7 claves
 Exterior/interior
 7 pins key - External/Internal
 Chave de 7 pinos

bombillo 50 mm

	Ref.	Embalaje
Pintado (caja)	01050	12
Niquelado (caja)	01051	12

bombillo 70 mm

	Ref.	Embalaje
Pintado (caja)	01558	12
Niquelado (caja)	01560	1

bombillo 90 mm

	Ref.	Embalaje
Pintado (caja)	01858	1
Niquelado (caja)	01860	1

201L/80

SISTEMA L

bombillo 50 mm

	Ref.	Embalaje
Pintado (caja)	01189	12
Niquelado (caja)	01190	12
Dorado (caja)	01191	1

bombillo 70 mm

	Ref.	Embalaje
Pintado (caja)	01500	1
Niquelado (caja)	01501	1
Dorado (caja)	01502	1

A 85
 B 82
 C 42
 D 150
 E 33
 F 165
 G 50
 70
 OPCIONAL 90

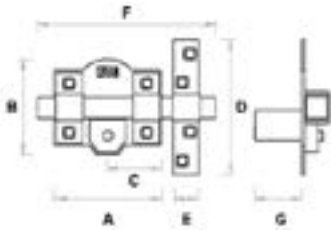

Llave de 7 claves
 Exterior/interior
 7 pins key - External/Internal
 Chave de 7 pinos



Acabado pintado, niquelado y dorado
 Barra de acero calibrado de 18 mm
 Placa de acero de 2 mm
 Cerradero en acero de 3 mm
 Cilindro de latón de 50-70 mm de longitud

Painted, nickel plated and golden finish
 18 mm steel bar
 2 mm steel plate
 3 mm steel striking plate
 Brass cylinder: 50-70 mm length

Acabamento pintado, niquelado e dourado
 Barra em aço de 18 mm
 Placa em aço de 2 mm
 Trocador em aço de 3 mm
 Cilindro em latão de 50-70 mm de longitude



Acabado pintado, niquelado y dorado
 Barra de acero calibrado de 18 mm
 Placa de acero de 2 mm
 Cerradero en acero de 3 mm
 Cilindro de latón de 50-70 mm de longitud

Painted, nickel plated and golden finish
 18 mm steel bar.
 2 mm steel plate
 3 mm steel striking plate
 Brass cylinder: 50-70 mm length

Acabamento pintado, niquelado e dourado
 Barra em aço de 18 mm
 Placa em aço de 2 mm
 Trocador em aço de 3 mm
 Cilindro em latão de 50-70 mm de longitude

A 85
 B 63
 C 42
 D 150
 E 33
 F 165
 G 50
 70
 OPCIONAL 90

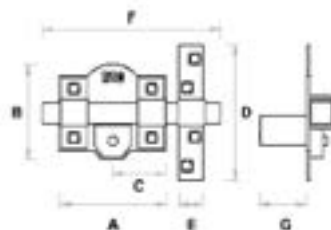

Llave de 7 claves
 Exterior/interior
 7 pins key - External/Internal
 Chave de 7 pinos

301L/80

SISTEMA L

bombillo 50 mm

	Ref.	Embalaje
Pintado (caja)	01107	12
Niquelado (caja)	01108	12
	(blister)	6
Dorado (caja)	01109	1
	(blister)	6

bombillo 70 mm

	Ref.	Embalaje
Pintado (caja)	01509	1
Niquelado (caja)	01510	12
Dorado (caja)	01511	1

301L/120

SISTEMA L

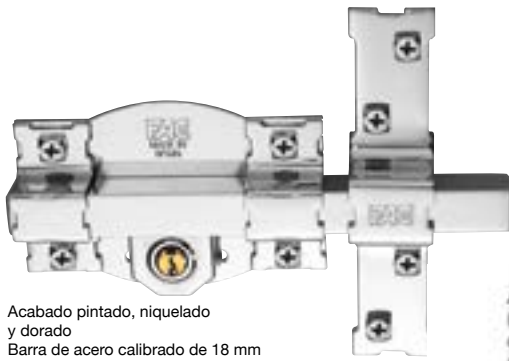

Acabado pintado, niquelado y dorado
 Barra de acero calibreado de 18 mm
 Placa de acero de 2 mm
 Cerradero en acero de 3 mm
 Cilindro de latón de 50-70 mm de longitud

Painted, nickel plated and golden finish
 18 mm steel bar
 2 mm steel plate
 3 mm steel striking plate
 Brass cylinder: 50-70 mm length

Acabamento pintado, niquelado e dourado
 Barra em aço de 18 mm
 Placa em aço de 2 mm
 Trocador em aço de 3 mm
 Cilindro em latão de 50-70 mm de longitude

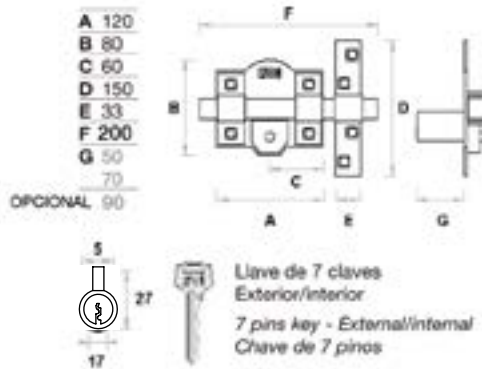

bombillo 50 mm			
		Ref.	Embalaje
Pintado	(caja)	01116	12
Niquelado	(caja)	01117	12
Dorado	(caja)	01118	1
bombillo 70 mm			
		Ref.	Embalaje
Pintado	(caja)	01515	1
Niquelado	(caja)	01516	1
Dorado	(caja)	01517	1

21

302L/115

SISTEMA L

bombillo 50 mm			
		Ref.	Embalaje
Pintado	(dcha.)	01122	12
	(izqda.)	01123	12
Niquelado	(dcha.)	01124	12
	(izqda.)	01125	12
bombillo 70 mm			
		Ref.	Embalaje
Pintado	(dcha.)	01521	1
	(izqda.)	01522	1
Niquelado	(dcha.)	01523	1
	(izqda.)	01524	1

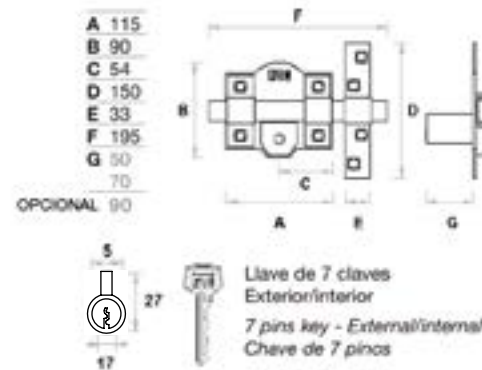

Acabado pintado y niquelado
 Barra de acero calibreado de 18 mm
 Placa de acero de 2 mm
 Cerradero en acero de 3 mm
 Cilindro de latón de 50-70 mm de longitud

Painted and nickel plated finish
 18 mm steel bar
 2 mm steel plate
 3 mm steel striking plate
 Brass cylinder: 50-70 mm length

Acabamento pintado e niquelado
 Barra em aço de 18 mm
 Placa em aço de 2 mm
 Trocador em aço de 3 mm
 Cilindro em latão de 50-70 mm de longitude

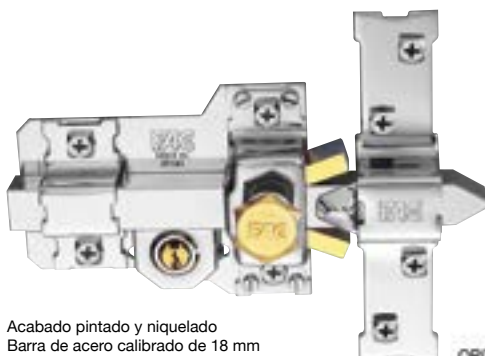

Acabado pintado y niquelado
 Barra de acero calibreado de 18 mm
 Placa de acero de 2 mm
 Cerradero en acero de 3 mm
 Cilindro de latón de 50-70 mm de longitud

Painted and nickel plated finish
 18 mm steel bar
 2 mm steel plate
 3 mm steel striking plate
 Brass cylinder: 50-70 mm length

Acabamento pintado e niquelado
 Barra em aço de 18 mm
 Placa em aço de 2 mm
 Trocador em aço de 3 mm
 Cilindro em latão de 50-70 mm de longitude

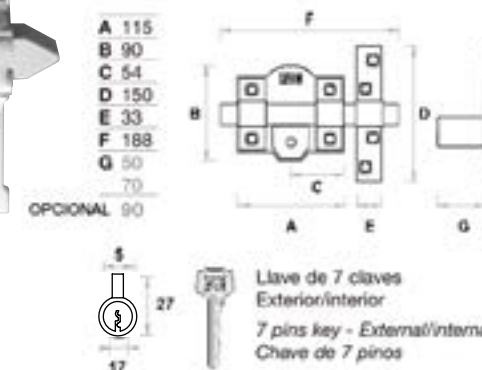

303L/115

SISTEMA L

bombillo 50 mm			
		Ref.	Embalaje
Pintado	(dcha.)	01130	1
	(izqda.)	01131	1
Niquelado	(dcha.)	01132	1
	(izqda.)	01133	1
bombillo 70 mm			
		Ref.	Embalaje
Pintado	(dcha.)	01527	1
	(izqda.)	01528	1
Niquelado	(dcha.)	01529	1
	(izqda.)	01530	1

306L/115

SISTEMA L



Acabado pintado y niquelado
Barra de acero calibreado de 18 mm
Placa de acero de 2 mm
Cerradero en acero de 3 mm
Cilindro de latón de 50-70 mm de longitud
Sistema con efecto resbalón

Acabamento pintado e niquelado
Barra em aço de 18 mm
Placa em aço de 2 mm
Trocador em aço de 3 mm
Cilindro em latão de 50-70 mm de longitude
Sistema com mecanismo de deslizamento

Painted and nickel plated finish
18 mm steel bar
2 mm steel plate
3 mm steel striking plate
Brass cylinder: 50-70 mm length
Latch system

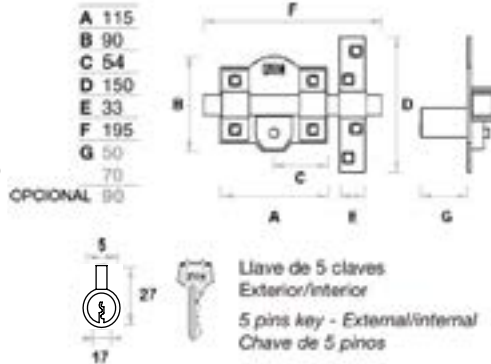

bombillo 50 mm			
		Ref.	Embalaje
Pintado	(dcha.)	01148	1
	(izqda.)	01149	1
Niquelado	(dcha.)	01150	1
	(izqda.)	01151	1

bombillo 70 mm			
		Ref.	Embalaje
Pintado	(dcha.)	01537	1
	(izqda.)	01538	1
Niquelado	(dcha.)	01539	1
	(izqda.)	01540	1

307L/80

SISTEMA L

bombillo 50 mm			
		Ref.	Embalaje
(caja) Niquelado	(dcha.)	01152	1
	(izqda.)	01153	1
(blister) Niquelado	(dcha.)	01352	6
	(izqda.)	01353	6
(caja) Dorado	(dcha.)	01154	1
	(izqda.)	01155	1
(blister) Dorado	(dcha.)	01354	6
	(izqda.)	01355	6

bombillo 70 mm			
		Ref.	Embalaje
Niquelado	(dcha.)	01541	1
	(izqda.)	01542	1
Dorado	(dcha.)	01543	1
	(izqda.)	01544	1

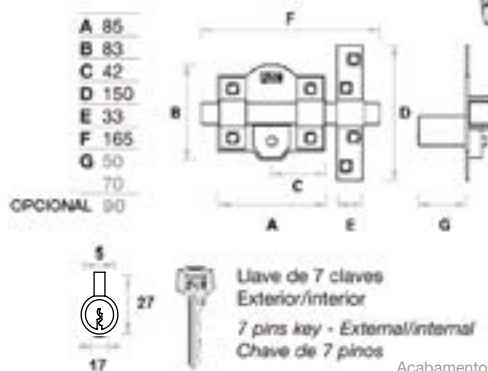

Acabamento niquelado e dourado
Barra em aço de 18 mm
Placa em aço de 2 mm
Trocador em aço de 3 mm
Cilindro em latão de 50-70 mm de longitude
Corrente de segurança com anéis de 3 mm de espessura

Acabado niquelado y dorado
Barra de acero calibreado de 18 mm
Placa de acero de 2 mm
Cerradero en acero de 3 mm
Cilindro de latón de 50-70 mm de longitud
Cadena retenedora con eslabones de Ø 3 mm

Nickel plated and golden finish
18 mm steel bar
2 mm steel plate
3 mm steel striking plate
Brass cylinder: 50-70 mm length
Ø 3 mm welded chain retainer

311L/80 classic

SISTEMA L

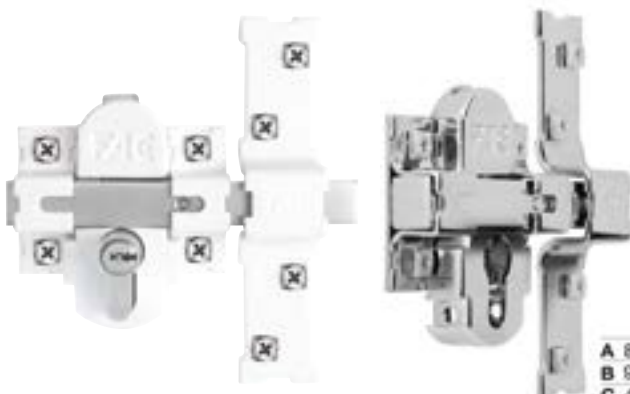

C/C (con cilindro) S/C (sin cilindro)

Acabado niquelado y pintado dorado, plata, blanco y marrón
Barra de acero de 18 x 15 mm
Placa de acero de 2 mm
Cerradero en acero de 3 mm
Cilindro de perfil europeo de 55x30 mm de longitud

Nickel plated and golden, silver, white and brown painted finish
18 x 15 mm steel bar
2 mm steel plate
3 mm steel striking plate
Brass cylinder: 55x30 mm length

Acabamento niquelado e pintado de ouro, prata, branco e marrom
Barra em aço de 18 x 15 mm
Placa em aço de 2 mm
Trocador em aço de 3 mm
Cilindro em latão de 55x30 mm de longitude

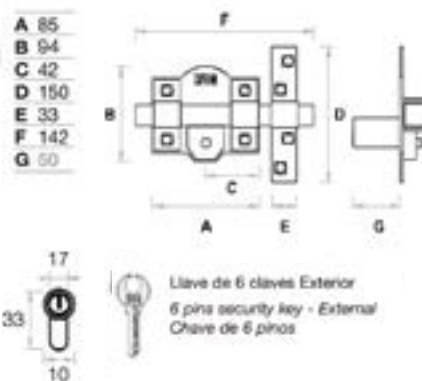

bombillo 55 x 30 mm			
		Ref.	Embalaje
Niquelado	C/C	01600	1
Plata	C/C	01601	1
Blanco	C/C	01602	1
Marrón	C/C	01603	1
Dorado	C/C	01604	1
Cromo Sat.	C/C	01605	1
Niquelado	S/C	01610	1
Plata	S/C	01611	1
Blanco	S/C	01612	1
Marrón	S/C	01613	1
Dorado	S/C	01614	1
Cromo Sat.	S/C	01615	1
Accesorio escudo		01699	1

301LP/80

SISTEMA L

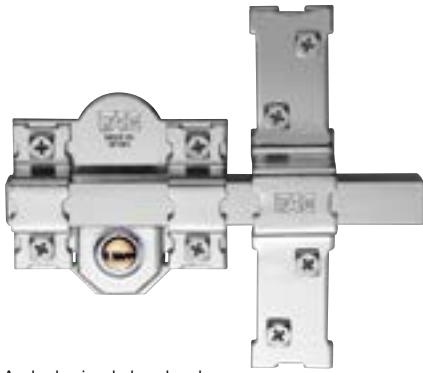

A 85
B 83
C 42
D 150
E 33
F 165
G 50

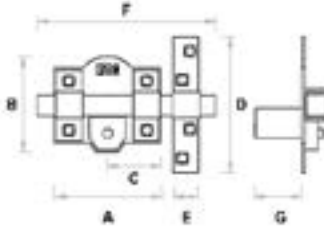

Acabado niquelado y dorado
Barra de acero calibreado de 18 mm
Placa de acero de 2 mm
Cerradero en acero de 3 mm
Cilindro de latón de 50 mm de longitud

Nickel plated and golden finish
18 mm steel bar
2 mm steel plate
3 mm steel striking plate
Brass cylinder: 50 mm length

Acabamento niquelado e dourado
Barra em aço de 18 mm
Placa em aço de 2 mm
Trocaador em aço de 3 mm
Cilindro em latão de 50 mm de longitude



Llave de 6 claves
Exterior/Interior
6 pins key - External/internal
Chave de 6 pinos.

bombillo 50 mm

	Ref.	Embalaje
Niq. Comp. (caja)	01209	1
Niquelado (caja)	01210	1
Dorado (caja)	01211	1

bombillo 70 mm

	Ref.	Embalaje
Níquel (caja)	01563	1
Dorado (caja)	01564	1

23

946LP/80

UVE SISTEMA L

bombillo 50 mm

	Ref.	Embalaje
Níquel (caja)	01240	1
Dorado (caja)	01241	1

Níquel (blister)	01340	1
Dorado (blister)	01341	1

bombillo 70 mm

	Ref.	Embalaje
Níquel (caja)	01597	1
Dorado (caja)	01599	1

ANTI-EXTRACCIÓN
(nueva placa de sujeción del bombillo en acero)

ANTI-IMPRESSING

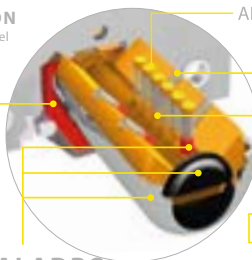

ANTI-TALADRO
(casquillo y disco giratorio en acero carbonitrurado primer pito en acero inoxidable)

ANTI-BUMPING

(pitos diábolo flotantes dispuestos en nuevo sistema en V)

ANTI-GANZÚA

(pitos diábolo alternos y pitos diábolo flotantes dispuestos en nuevo sistema en V)

PLACA TRASERA NIVELADORA
(enrasa el cerradero y facilita su instalación con sus líneas rectas)



ANTI-PALANQUETA
(nuevo cerradero solapado adicional anti-palanqueta)

Acabado niquelado y dorado
Barra de acero calibreado de 18 mm
Placa de acero de 2 mm
Cerradero en acero de 3 mm
Cilindro de latón de 50 mm de longitud

Nickel plated and golden finish
18 mm steel bar
2 mm steel plate
3 mm steel striking plate
Brass cylinder: 50 mm length

Acabamento niquelado e dourado
Barra em aço de 18 mm
Placa em aço de 2 mm
Trocaador em aço de 3 mm
Cilindro em latão de 50 mm de longitude

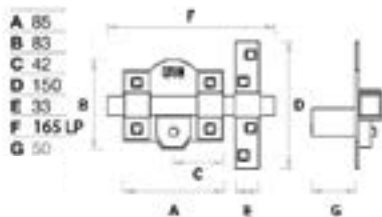

Llave de 6 claves Exterior
6 pins security key - External
Chave de 6 pinos



A 130
B 75
C 65
D -
E -
F 208
G 28

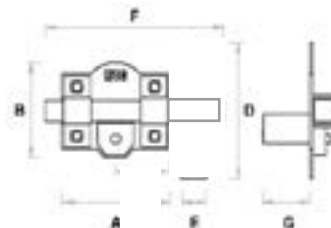

Acabado niquelado
Barra en pletina de acero calibreado de 25x10 mm
Placa de acero de 2 mm
Cilindro de latón de 28 mm de longitud

Nickel plated finish
Steel bar of 25x10 mm
2 mm steel plate
Brass cylinder: 28 mm length

Acabamento niquelado
Barra em aço de 25x10 mm
Placa em aço de 2 mm
Cilindro em latão de 28 mm de longitude



Llave de 6 claves Exterior
6 pins key - External
Chave de 6 pinos

304DF/130

SISTEMA L

bombillo 28 mm

	Ref.	Embalaje
Juego de 2 Niquelado (caja)	01139	1

301R/80 caja T

SISTEMA T 2 GIROS



2 giros de llave

Acabado niquelado
Barra en acero calibrado de 18 mm
Placa en acero de 2 mm
Cerradero en acero de 3 mm
Cilindro de latón de 50-70-90 mm de longitud

Nickel finish
18 mm steel bar
2 mm steel plate
3 mm steel striking plate
Brass cylinder: 50-70-90 mm length

Acabamento niquelado
Barra em aço de 18 mm
Placa em aço de 2 mm
Trocador em aço de 3 mm
Cilindro em latão de 50-70-90 mm de longitude

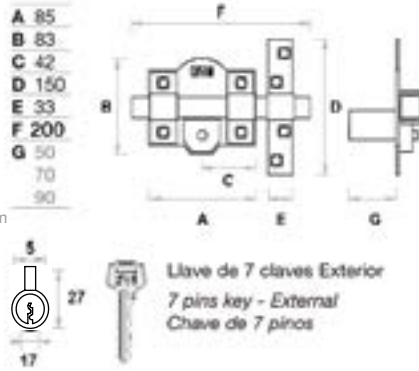

bombillo 50 mm		
	Ref.	Embalaje
Niquelado (caja)	01012	1
bombillo 70 mm		
	Ref.	Embalaje
Niquelado (caja)	01591	1
bombillo 90 mm		
	Ref.	Embalaje
Niquelado (caja)	01816	1

302T/115

SISTEMA T

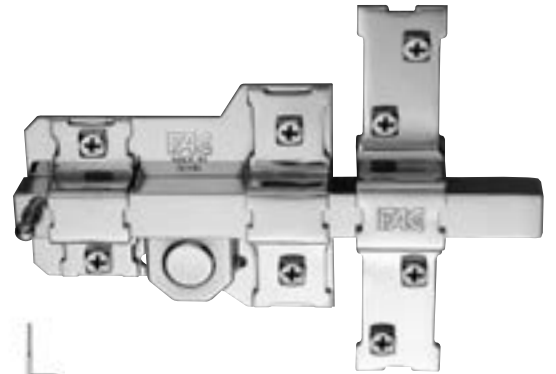

bombillo 50 mm		
	Ref.	Embalaje
Niquelado (dcha.)	01128	1
(izqda.)	01129	1
bombillo 70 mm		
	Ref.	Embalaje
Niquelado (dcha.)	01525	1
(izqda.)	01526	1
bombillo 90 mm		
	Ref.	Embalaje
Niquelado (dcha.)	01825	1
(izqda.)	01826	1

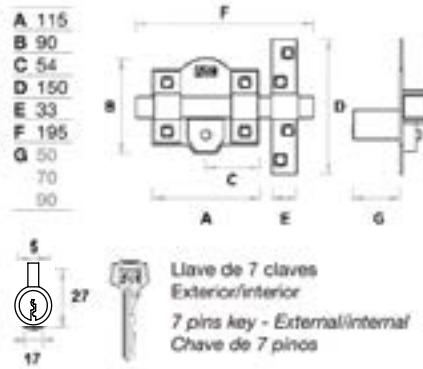

Acabado niquelado
Barra de acero calibrado de 18 mm
Placa de acero de 2 mm
Cerradero en acero de 3 mm
Cilindro de latón de 50-70-90 mm de longitud

Nickel plated finish
18 mm steel bar
2 mm steel plate
3 mm steel striking plate
Brass cylinder: 50-70-90 mm length

Acabamento niquelado
Barra em aço de 18 mm
Placa em aço de 2 mm
Trocador em aço de 3 mm
Cilindro em latão de 50-70-90 mm de longitude

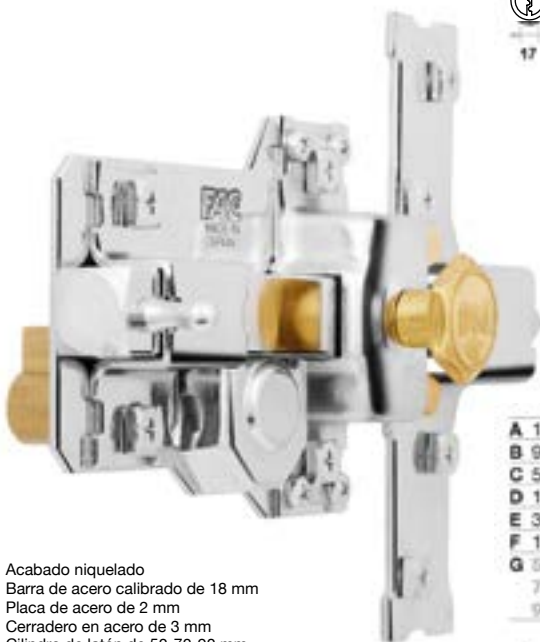

Acabado niquelado
Barra de acero calibrado de 18 mm
Placa de acero de 2 mm
Cerradero en acero de 3 mm
Cilindro de latón de 50-70-90 mm de longitud

Nickel plated finish
18 mm steel bar
2 mm steel plate
3 mm steel striking plate
Brass cylinder: 50-70-90 mm length

Acabamento niquelado
Barra em aço de 18 mm
Placa em aço de 2 mm
Trocador em aço de 3 mm
Cilindro em latão de 50-70-90 mm de longitude

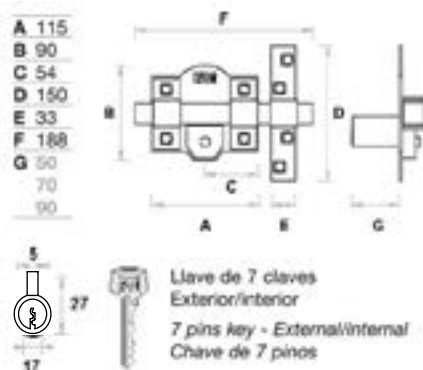

303T/115

SISTEMA T

bombillo 50 mm		
	Ref.	Embalaje
Niquelado (dcha.)	01136	1
(izqda.)	01137	1
bombillo 70 mm		
	Ref.	Embalaje
Niquelado (dcha.)	01531	1
(izqda.)	01532	1
bombillo 90 mm		
	Ref.	Embalaje
Niquelado (dcha.)	01831	1
(izqda.)	01832	1

304F/130

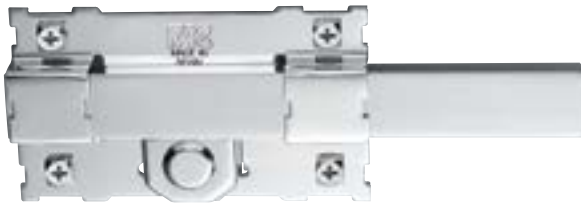

Acabado niquelado
 Barra en pletina de acero calibrado de 25x10 mm
 Placa de acero de 2 mm
 Cilindro de latón de 28 mm de longitud

Nickel plated finish
 Steel bar of 25x10 mm
 2 mm steel plate
 Brass cylinder: 28 mm length

Acabamento niquelado
 Barra em aço de 25x10 mm
 Placa em aço de 2 mm
 Cilindro em latão de 28 mm de longitude

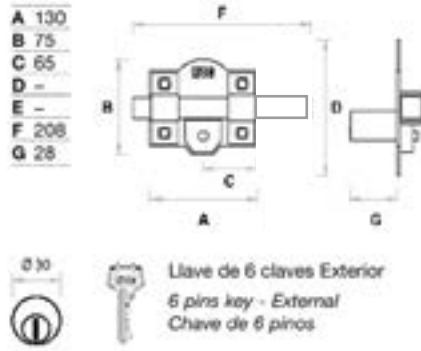

bombillo 28 mm

Juego de 2	Ref.	Embalaje
Niquelado (caja)	01138	1



304FP/130

Acabado niquelado
 Barra en pletina de acero calibrado de 25x10 mm
 Placa de acero de 2 mm
 Cilindro de latón de 28 mm de longitud

Nickel plated finish
 Steel bar of 25x10 mm
 2 mm steel plate
 Brass cylinder: 28 mm length

Acabamento niquelado
 Barra em aço de 25x10 mm
 Placa em aço de 2 mm
 Cilindro em latão de 28 mm de longitude

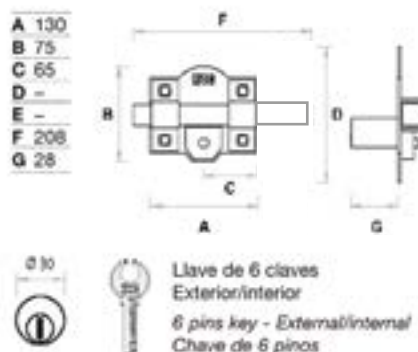

bombillo 28 mm

Juego de 2	Ref.	Embalaje
Niquelado (caja)	01099	1

CONJUNTO de SEGURIDAD CLÓNICOS

Puede solicitarse con otro modelo de cerrojo de llaves planas

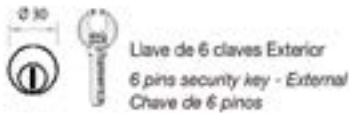
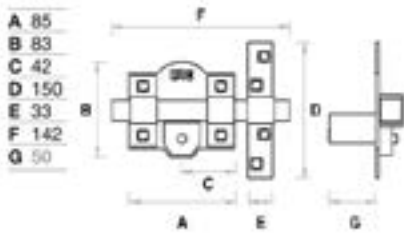

Conjunto de seguridad clónico

Compuesto por cerrojo y cilindro de perfil europeo fabricados con llaves de puntos o planas.

Las claves del cilindro de perfil europeo y las del cerrojo son diferentes.

Cada componente se suministra con su propia llave y a su vez se facilita una llave denominada LLAVE DE FAMILIA que abre ambos dispositivos.

Cilindros disponibles:

40x30 LLAVE/POMO - LEVA 15

40x40 LLAVE/LLAVE - LEVA 15

35X35 LLAVE/LLAVE - LEVA 15

Puede solicitarse con otro modelo de cerrojo de llaves planas.

Master key security set

Composed by one locking bolt and one europrofile cylinder to be operated with security keys.

The cylinder and the lock key codes are different.

Each item has its own key and an extra master key called "FAMILY KEY" is supplied to operate both locking devices

Available cylinders:

40x30 KEY/KNOB - 15 mm CAM

40x40 KEY/KEY - 15 mm CAM

35X35 KEY/KEY - 15 mm CAM

Available with any other locking bolt operated with security key (under request).

Conjunto de segurança clónico

Formado por um ferrolho e cilindro de perfil europeu fabricados com chaves de pontos ou dentadas.

Os segredos do cilindro de perfil europeu e os do ferrolho são diferentes.

Cada componente é fornecido com a sua própria chave e ainda com uma chave denominada CHAVE DE FAMILIA que abre ambos os dispositivos.

Cilindros disponíveis:

40x30 Chave/Manipulo, lingueta 15

40x40 Chave/Chave, lingueta 15

35x35 Chave/Chave, lingueta 15

Pode fornecer-se com outro modelo de ferrolho de chaves dentadas.

clónicos / master key / clónicos

	Ref.	Embalaje
Cilindro perfil europeo latón 40 x 30 mm Llave exterior / pomo cromado interior Leva 15 mm	01212	1
Cerrojo 301 LP/80 niquelado Llave exterior / interior		
Cilindro perfil europeo latón 40 x 30 mm Llave exterior / pomo dorado interior Leva 15 mm	01213	1
Cerrojo 301 LP/80 dorado Llave exterior / interior		
Cilindro perfil europeo latón 40 x 40 mm Llave exterior / interior Leva 15 mm	01216	1
Cerrojo 301 RP/80 niquelado Llave exterior / pulsador y tirador interior		
Cilindro perfil europeo latón 40 x 40 mm Llave exterior / interior Leva 15 mm	01217	1
Cerrojo 301 RP/80 dorado Llave exterior / pulsador y tirador interior		
Cilindro perfil europeo latón 35 x 35 mm Llave exterior / interior Leva 15 mm	01226	1
Cerrojo 301 RP/80 niquelado Llave exterior / pulsador y tirador interior		
Cilindro perfil europeo latón 35 x 35 mm Llave exterior / interior Leva 15 mm	01227	1
Cerrojo 301 RP/80 dorado Llave exterior / pulsador y tirador interior		

CONJUNTO de SEGURIDAD

MISMA CLAVE

Puede solicitarse con otro modelo de cerrojo de llaves planas

27

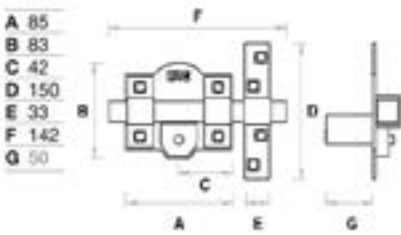
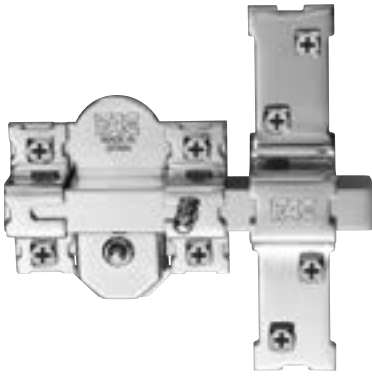

Llave de 6 claves Exterior
6 pins security key - External
Chave de 6 pinos



misma clave / key alike / mesma chave

	Ref.	Embalaje
Cilindro perfil europeo latón 40 x 30 mm Llave exterior / pomo cromado interior Leva 15 mm Cerrojo 301 LP/80 níquelado Llave exterior / interior	01214	1
Cilindro perfil europeo latón 40 x 30 mm Llave exterior / pomo dorado interior Leva 15 mm Cerrojo 301 LP/80 dorado Llave exterior / interior	01215	1
Cilindro perfil europeo latón 40 x 40 mm Llave exterior / interior Leva 15 mm Cerrojo 301 RP/80 níquelado Llave exterior / pulsador y tirador interior	01218	1
Cilindro perfil europeo latón 40 x 40 mm Llave exterior / interior Leva 15 mm Cerrojo 301 RP/80 dorado Llave exterior / pulsador y tirador interior	01219	1
Cilindro perfil europeo latón 35 x 35 mm Llave exterior / interior Leva 15 mm Cerrojo 301 RP/80 níquelado Llave exterior / pulsador y tirador interior	01228	1
Cilindro perfil europeo latón 35 x 35 mm Llave exterior / interior Leva 15 mm Cerrojo 301 RP/80 dorado Llave exterior / pulsador y tirador interior	01229	1
Cilindro perfil europeo níquelado 40 x 40 mm Llave exterior / interior Leva 15 mm Cerrojo 301 RP/80 níquelado completo Llave exterior / pulsador y tirador interior	01230	1
Cilindro perfil europeo níquelado 35 x 35 mm Llave exterior / interior Leva 15 mm Cerrojo 301 RP/80 níquelado completo Llave exterior / pulsador y tirador interior	01231	1

Conjunto de seguridad misma clave

Compuesto por cerrojo y cilindro de perfil europeo fabricados con llaves de puntos o planas. Las claves del cilindro de perfil europeo y las del cerrojo son Cualquier llave del conjunto abre tanto el cilindro de perfil europeo como el cerrojo.

Cilindros disponibles:

- 40x30 LLAVE/POMO - LEVA 15
- 40x40 LLAVE/LLAVE - LEVA 15
- 35X35 LLAVE/LLAVE - LEVA 15

Puede solicitarse con otro modelo de cerrojo de llaves planas.

Key alike security set

Composed by one locking bolt and one europrofile cylinder to be operated with security keys.

The cylinder and the lock key codes are alike.

The same key operates both the europrofile cylinder and the locking bolt.

Available cylinders:

- 40x30 KEY/KNOB - 15 mm CAM
- 40x40 KEY/KEY - 15 mm CAM
- 35X35 KEY/KEY - 15 mm CAM

Available with any other locking bolt operated with security key (under request).

Conjunto de segurança mesma chave

Formado por um ferrolho e cilindro de perfil europeu fabricados com chaves de pontos ou dentadas.

Os segredos do cilindro de perfil europeu e os do ferrolho são iguais.

Qualquer chave do conjunto abre tanto o cilindro de perfil europeu como o ferrolho.

Cilindros disponíveis:

- 40x30 Chave/Manipulo, lingueta 15
- 40x40 Chave/Chave, lingueta 15
- 35x35 Chave/Chave, lingueta 15.

Pode fornecer-se com outro modelo de ferrolho de chaves dentadas.



“En 1931 patentamos nuestro primer cerrojo, el nº 1.
Ahora reeditamos el original”

“La opción perfecta para puerta antigua o rústica”

ORO: bañado en oro de 18 quilates
ÓXIDO y NEGRO: acabado epoxy,
de alta resistencia a la corrosión.

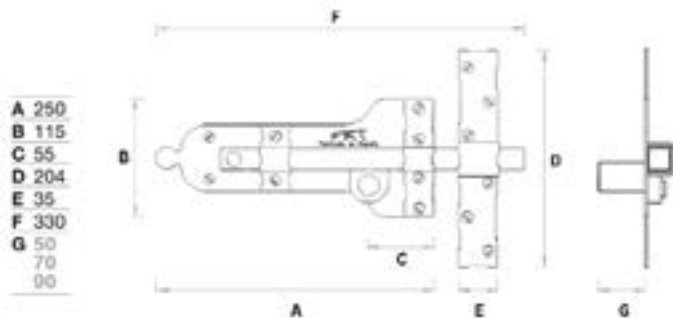

Llave de 7 claves
Exterior/interior
7 pins key - External/internal
Clave de 7 pines

bombillo 50 mm

	Ref.	Embalaje
Óxido	(dcha.) 01900	1
	(izqda.) 01909	1
Negro	(dcha.) 01903	1
	(izqda.) 01912	1
Oro	(dcha.) 01906	1
	(izqda.) 01915	1

bombillo 70 mm

	Ref.	Embalaje
Óxido	(dcha.) 01901	1
	(izqda.) 01910	1
Negro	(dcha.) 01904	1
	(izqda.) 01913	1
Oro	(dcha.) 01907	1
	(izqda.) 01916	1

bombillo 90 mm

	Ref.	Embalaje
Óxido	(dcha.) 01902	1
	(izqda.) 01911	1
Negro	(dcha.) 01905	1
	(izqda.) 01914	1
Oro	(dcha.) 01908	1
	(izqda.) 01917	1

***nº 1 SISTEMA L opcional**
(llave interior / exterior)
bombillo de **50 mm**, **70 mm** y **90 mm**

ANTI-IMPACTO

RETENEDOR

29



Innovador sistema anti-impacto
 Fabricado en acero 100% tallado en torno CNC y cortado en laser
 Muelle interno destinado a absorber la energía del impacto
 Acabados: cromo brillo, cromo satinado y dorado
 Sólo disponible en blíster

An innovating anti-impact system
 Made in 100% steel worked in lathe CNC and laser cutting
 Internal spring to absorb the impact energy
 Finish: polished chrome, satin chrome and golden finish
 Only available in blister

Um inovador sistema anti-impacto
 Fabricado em aço 100% modelado em torno CNC e cortado com laser
 Mola interna destinada a absorver a energia do impacto
 Acabamentos em cromo brilhante, cromo acetinado e dourado
 Em Blister

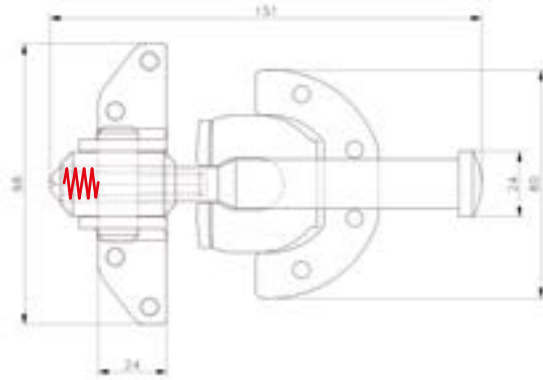

retenedor		
	Ref.	Embalaje
Cr. Satinado	03355	6
Dorado	03356	6
Cromado	03357	6

600

RETENEDOR



Acabado níquelado y dorado
 Placa en chapa de acero de 2 mm
 Cadena soldada con eslabón de Ø 3 mm

Nickel plated and golden finish
 2 mm steel plate
 Ø 3 mm welded chain retainer

Acabamento níquelado e dourado
 Placa em aço de 2 mm
 Corrente de segurança com anéis de 3 mm

retenedor		
	Ref.	Embalaje
Níquelado	03351	12
Dorado	03352	12

700

PIVOTES

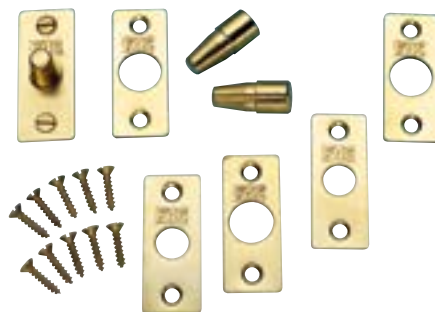

Pivotes de acero de 13 mm
 Placa de acero de 2,1 mm
 Placa de acabado latonado

13 mm steel bolts
 2,1 mm steel plate
 Brass plated finish

Trincos em aço de 13 mm
 Placa em aço de 2,1 mm
 Placa em acabamento latão

Refuerzo zona de bisagra

pivotes para bisagra		
Juego de 3	Ref.	Embalaje
Dorado	08551	12

CONJUNTO de SEGURIDAD

MISMA CLAVE RK UVE



946 RK UVE (igualado a cilindro RK)

		Ref.	Embalaje
Níquel	(caja)	01080	1
Dorado	(caja)	01081	1

446 RK MAGNET UVE (igualado a cilindro RK)

		Ref.	Embalaje
Níquel	(caja)	01924	1
Dorado	(caja)	01925	1
Cromo satinado	(caja)	01926	1
Blanco	(caja)	01927	1

Conjunto de seguridad misma clave.

Compuesto por cerrojo y cilindro de perfil europeo fabricados con llave de puntos o planas. Las llaves del conjunto abren tanto el cilindro de perfil europeo como el cerrojo.

Key alike security set

Composed by one locking bolt and one europrofile cylinder to be operated with security keys. The cylinder and the lock key codes are alike. The same key operates both the europrofile cylinder and the locking bolt.

Conjunto de segurança mesma chave

Formado por um ferrolho e cilindro de perfil europeu fabricados com chaves de pontos ou dentadas. Os segredos do cilindro de perfil europeu e os do ferrolho são iguais.

Qualquer chave do conjunto abre tanto o cilindro de perfil europeu como o ferrolho.

Estas referencias pueden igualarse a cualquier medida de cilindro de la serie RK. Para configurar el pedido se debe seleccionar la referencia del cerrojo detallada en esta pagina y añadir la referencia del cilindro de la serie RK deseada.

Para mayor información de los cilindros de la serie RK, refiérase a la pag. 69.

Los precios de estos cerrojos incluyen el servicio de igualamiento.

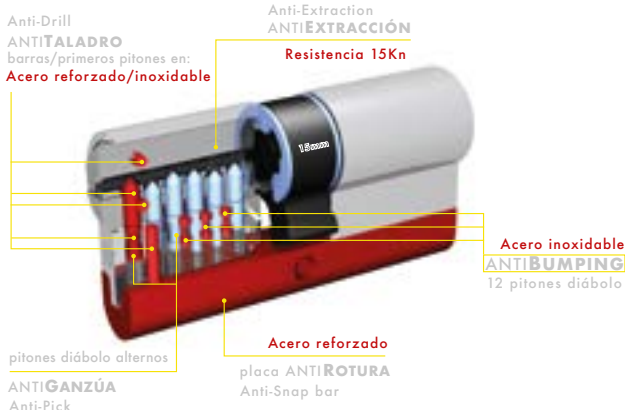

leva 15 mm (5 llaves)

			C	A	B	Ref.	Emb.
RK	Latón	(caja)	60	30	30	23237	12
RK	Latón	(caja)	70	30	40	23238	12
RK	Latón	(caja)	70	35	35	23239	12
RK	Latón	(caja)	80	30	50	23240	12
RK	Latón	(caja)	80	40	40	23241	12

leva 15 mm (5 llaves)

			C	A	B	Ref.	Emb.
RK	Níquel sat.	(caja)	60	30	30	23253	12
RK	Níquel sat.	(caja)	70	30	40	23254	12
RK	Níquel sat.	(caja)	70	35	35	23255	12
RK	Níquel sat.	(caja)	80	30	50	23256	12
RK	Níquel sat.	(caja)	80	40	40	23257	12



CERROJO 906-R/200 SPA PINTADO

Longitud de cilindro: 50. Opcional: 70, 90, 100 y 120 mm.

Barra doble anti-radial: Pieza metálica con cremallera de engranaje instalada en el cerrojo, capaz de penetrar en el cerradero y bloquear la apertura de la puerta. Contiene 2 dispositivos anti-radial para reforzar la barra y aumentar la seguridad.



Longitud de cilindro: 50. Opcional: 70, 90, 100 y 120 mm.

Sistema de Igualamiento o Misma llave y Amaestramiento y Amaestramiento GM (gran maestra)

Tipo de llave: Serreta. Opcionalmente, se puede fabricar con llave de puntos o de seguridad.

El control de cerrar y abrir puertas de gran tamaño no solo es aplicable a las puertas abatibles de los contenedores de carga de los camiones. Este cerrojo se puede instalar en cualquier puerta de acceso de grandes dimensiones.



CERROJO EN PAREJA 906-R/80 SCP B-70 mm. PINTADO

Longitud de cilindro: 70. Opcional: 90, 100 y 120 mm.

906 R			
		Ref.	Embalaje
200 SPA	(caja)	01015	1
80 SCP	(caja)	01594	1



Llave de 6 claves Exterior
6 pins key - External
Chave de 6 pinos

Sistema solo llave: Accionamiento exclusivo por el exterior. Por el interior no se puede accionar



PASADORES

Colocación a derecha, izquierda o vertical indistintamente.
Se acciona tirando del tirador que desbloquea la barra.

Possibility of mounting right, left or vertical.
It's worked sliding the bar through the knob.

Montagem á direita, esquerda ou vertical indistintamente.
É accionando retirando o puxador que desbloqueia a barra.

P 86 PASADOR

Acabado níquelado y dorado
Barra de acero calibrado de 18 mm
Placa de acero de 2 mm
Cerradero en acero de 3 mm
Cadena retenedora con eslabones
de Ø 3 mm

Nickel plated and golden finish
18 mm steel bar
2 mm steel plate
3 mm steel striking plate
Ø 3 mm welded chain retainer

Acabamento níquelado e dourado
Barra em aço de 18 mm
Placa em aço de 2 mm
Trocaador em aço de 3 mm
Corrente de segurança com anéis
de 3 mm de espessura

A 85
B 82
C 33
D 150

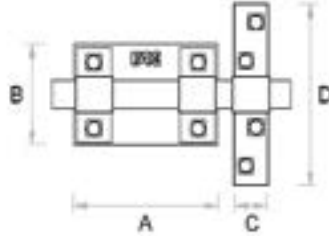

sin llave		
	Ref.	Embalaje
Níquelado (caja)	12111	1
Dorado (caja)	12112	1
Níquelado (blister)	12114	6
Dorado (blister)	12115	6
Cr. Satinado (blister)	12116	6

P 87 PASADOR

sin llave		
	Ref.	Embalaje
Níquelado (caja)	12101	1
Dorado (caja)	12102	1
Dorado (blister)	12103	12
Níquelado (blister)	12104	12
Óxido (blister)	12105	12
Negro ox. (blister)	12106	12
Cr. Satinado (blister)	12107	12

A 87
B 62
C 26
D 117

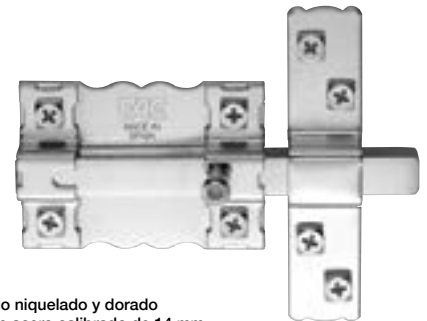
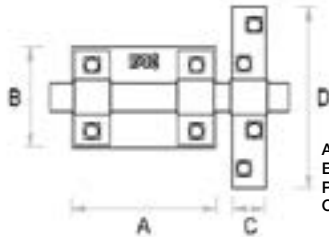

Acabado níquelado y dorado
Barra de acero calibrado de 14 mm
Placa de acero de 2 mm
Cerradero en acero de 3 mm

Nickel plated and golden finish
14 mm steel bar
2 mm steel plate
3 mm steel striking plate

Acabamento níquelado e dourado
Barra em aço de 14 mm
Placa em aço de 2 mm
Trocaador em aço de 3 mm



Acabado níquelado y dorado
Barra de acero calibrado de 8 mm
Placa de acero de 1,5 mm
Cerradero en acero de 1,5 mm
Sólo disponible en blister

Nickel plated and golden finish
8 mm steel bar
1,5 mm steel plate
1,5 mm steel striking plate
Only available in blister

Acabamento níquelado e dourado
Barra em aço de 8 mm
Placa em aço de 1,5 mm
Trocaador em aço de 1,5 mm
Em Blister

A 56
B 40
C 15
D 50

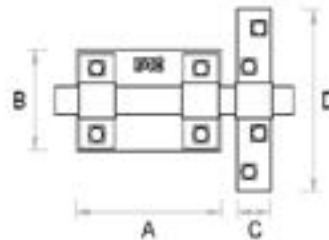

P 88 PASADOR

sin llave		
	Ref.	Embalaje
Níquelado	12192	12
Dorado	12193	12

P 89 PASADOR

sin llave		
	Ref.	Embalaje
Níquelado	12194	12
Dorado	12195	12

A 32
B 30
C 12
D 40

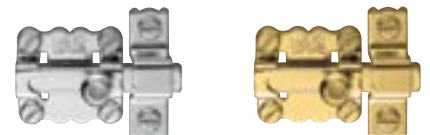
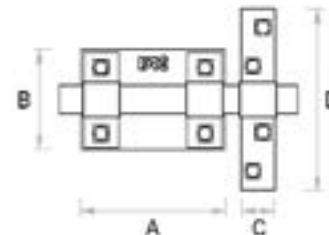

Acabado níquelado y dorado
Barra de acero calibrado de 8 mm
Placa de acero de 1,5 mm
Cerradero en acero de 1,5 mm
Sólo disponible en blister

Acabamento níquelado e dourado
Barra em aço de 8 mm
Placa em aço de 1,5 mm
Trocaador em aço de 1,5 mm
Em Blister

Nickel plated and golden finish
8 mm steel bar
1,5 mm steel plate
1,5 mm steel striking plate
Only available in blister

MAGNET PASADOR

Colocación a derecha, izquierda o vertical indistintamente.
Se acciona tirando del tirador que desbloquea la barra.

Possibility of mounting right, left or vertical.
It's worked sliding the bar through the knob.

Montagem á direita, esquerda ou vertical indistintamente.
É accionando retirando o puxador que desbloqueia a barra.



pasador magnet

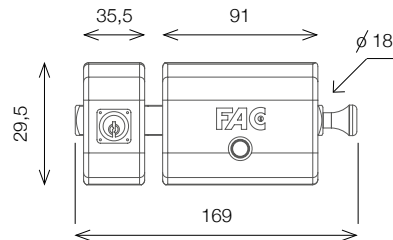

Gran seguridad con una fácil instalación.
Barra de acero de 18 mm.
Reversible.

sin llave			
		Ref.	Embalaje
Níquel	(caja)	12920	1
Dorado	(caja)	12921	1
Satinado	(caja)	12922	1
Blanco	(caja)	12923	1

kit carcasas			
		Ref.	Embalaje
Níquel	4 unidades	99327	1
Dorado	4 unidades	99328	1
Satinado	4 unidades	99329	1
Blanco	4 unidades	99330	1
Multi	4 unidades	99331	1

33

CARCASA MAGNÉTICA INTERCAMBIABLE

(4 acabados disponibles)



CPM



CS

CPM y CS

ESCUDO PROTECTOR CILINDRO

ESCUDOS CPM y CS

		Ref.	Embalaje
Escudo protector cilindro CPM (inox. mate)	4 uds.	99351	1
Escudo protector cilindro CPM (níquelado)	4 uds.	99352	1
Escudo protector cilindro CS (inox. mate)	3 uds.	99356	1
Escudo protector cilindro CS (níquelado)	3 uds.	99357	1
Escudo protector cilindro CS (dorado)	3 uds.	99358	1

El Escudo Protector CPM y CS combina diseño y seguridad, protegiendo al cilindro en su parte frontal y lateral. Ha sido diseñado para poder realizar una instalación rápida y sencilla.

Escudo fabricado en Acero Inoxidable, acompañado por un disco giratorio de 2 mm de espesor fabricado en acero al manganeso. Todo el conjunto protege al cilindro de ataques con taladro.

El diseño exterior en forma de pirámide truncada, dificulta el ataque con mordaza o llave grifa.



Se trata de un dispositivo metálico destinado a la protección de cilindros y que su función principal es dificultar el acceso y manipulación del cilindro ante posibles ataques con herramientas.

546 RP/80 **RK** ACORAZADO

SISTEMA R

ANTI-BUMPING/ANTI-IMPRESSIIONING



- Carcasa acorazada
- Escudo protector
- Llave RK Alta seguridad
- Anti-Bumping
- Anti-Impressioning
- Anti-Extracción
- Anti-Taladro
- Anti-Palanqueta
- Anti-Ganzúa

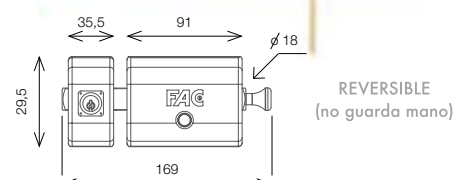

bombillo 50 mm			
		Ref.	Embalaje
Níquel	(caja)	01420	1
Dorado	(caja)	01421	1
Cromo satinado	(caja)	01422	1

bombillo 60 mm			
		Ref.	Embalaje
Níquel	(caja)	01425	1
Dorado	(caja)	01426	1
Cromo satinado	(caja)	01427	1

bombillo 70 mm			
		Ref.	Embalaje
Níquel	(caja)	01430	1
Dorado	(caja)	01431	1
Cromo satinado	(caja)	01432	1

NUEVO

521 RP/80 **KB** ACORAZADO

SISTEMA R



Acabados:
DORADO
NIQUELADO
CROMO SATINADO

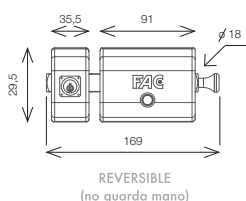

El cerrojo FAC 521-RP/80 KB ACORAZADO, está diseñado para combinarlo con un bombillo tipo inserto DORMA KABA de fácil acoplamiento en el interior del cañón o rotor, consiguiendo un cerrojo de gran calidad y seguridad.

INSERTO NO INCLUIDO. DISPONIBLE COMO ACCESORIO (ref. 07080) SIEMPRE SUJETO A LA COMPRA DE UN CERROJO 521 KB.
NO SE SIRVEN INSERTOS INDIVIDUALMENTE. CONSULTE A SU COMERCIAL EN CASO DE DUDA.

521 RP/80 KB acorazado			
		Ref.	Embalaje
Níquel	(caja)	01435	1
Dorado	(caja)	01436	1
Cromo satinado	(caja)	01437	1

521 RP/80 KB acorazado B-60 mm			
		Ref.	Embalaje
Níquel	(caja)	01440	1
Dorado	(caja)	01441	1
Cromo satinado	(caja)	01442	1

521 RP/80 KB acorazado B-70 mm			
		Ref.	Embalaje
Níquel	(caja)	01445	1
Dorado	(caja)	01446	1
Cromo satinado	(caja)	01447	1

NUEVO

FURGOFAC INOX

CIERRE TRANSPORTE PROFESIONAL



CF-19 FURGOFAC INOX

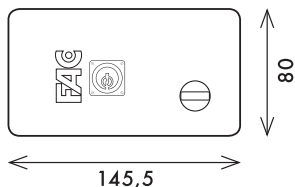

- Mucho más robusto y seguro que cualquier alternativa del mercado.
- Elevada resistencia a la intemperie. Fabricado en acero INOX AISI 316.
- Bombillo de seis claves con pitones de acero inoxidable, llave de seguridad FAC25.
- Instalación sencilla. Incluye plantilla adhesiva.
- Dispositivo de apertura de emergencia interior.
- Apropiado para su instalación en prácticamente cualquier modelo de furgoneta.
- QR de ayuda a la instalación (Video)
- Diseño reducido, estético y sin aristas.
- Incluye toda la tornillería (inox) necesaria para su instalación.
- Lamina EVA de protección de la carrocería.



35

CF-19 FURGOFAC INOX

		Ref.	Embalaje
unidad	(caja)	01990	1
PAREJA	(caja)	01991	2

DISPONIBLE EN PAREJA CON LA MISMA LLAVE, PARA SU INSTALACIÓN EN PORTÓN TRASERO Y LATERAL.

— POSIBILIDAD DE AMAESTRAMIENTOS —





cerraduras de embutir en madera

HIGH SECURITY MORTICE LOCKS · FECHADURAS DE EMBUTIR MADEIRA

FAC

201 · 202

Acabado latonado en frontal y cerradero
 Sistema de apertura y cierre compuesto por palanca y picaporte
 Picaporte reversible, accionado por llave y manilla por ambos lados
 Cilindro europerfil con leva de 15 mm*
 El cilindro acciona el picaporte y la palanca (2 vueltas)

Forend and striking plate with brass plated finish
 Opening and locking system of latch and deadbolt
 Reversible latch, working key and handle in both sides
 Europrofile cylinder with 15 mm cam*
 Cylinder works latch and deadbolt (double throw)

Tratamento final no frontal e chapatesta em latão
 Sistema de abertura e fecho composto por lingua e trinco
 Trinco reversível, accionado por chave e manípulo de ambos lados
 Cilindro de perfil europeu com lingueta de 15 mm* O cilindro acciona o trinco e a liedgua (2 voltas)

* Cilindro opcional. Optional cylinder. Canhão optional



201 · 202			
	Entrada	Ref.	Embalaje
201 cuadrado	40 mm	10201	6
202 redondo	40 mm	10202	6
201 cuadrado	50 mm	10203	6
202 redondo	50 mm	10204	6

203 · 204

Acabado cromo mate en frontal y cerradero
 Sistema de apertura y cierre compuesto por palanca y picaporte
 Picaporte reversible, accionado por llave y manilla por ambos lados
 Cilindro europerfil con leva de 15 mm*
 El cilindro acciona el picaporte y la palanca (2 vueltas)

Forend and striking plate with satin chrome plated finish
 Opening and locking system of latch and deadbolt
 Reversible latch, working key and handle in both sides
 Europrofile cylinder with 15 mm cam*
 Cylinder works latch and deadbolt (double throw)
 Tratamento final no frontal e chapatesta em cromo mate

Sistema de abertura e fecho composto por lingua e trinco
 Trinco reversível, accionado por chave e manípulo de ambos lados
 Cilindro de perfil europeu com lingueta de 15 mm* O cilindro acciona o trinco e a liedgua (2 voltas)

* Cilindro opcional. Optional cylinder. Canhão optional



203 · 204			
	Entrada	Ref.	Embalaje
203 cuadrado	40 mm	10205	6
204 redondo	40 mm	10206	6
203 cuadrado	50 mm	10207	6
204 redondo	50 mm	10208	6

701 · 702

Acabado en latón y cromado mate en frontal y cerradero
 Picaporte reversible, accionado por llave y manilla por ambos lados
 4 bulones de acero de Ø 14 mm
 Cilindro europerfil con leva de 15 mm*
 El cilindro acciona el picaporte y los bulones (2 vueltas)

Forend and striking plate with brass plated and satin chrome plated finish
 Reversible latch, working key and handle in both sides
 4 steel bolts of Ø 14 mm
 Europrofile cylinder with 15 mm cam*
 Cylinder works latch and bolt (double throw)
 Tratamento final no frontal em latão e cromado mate
 Trinco reversível, accionado por chave e manípulo de ambos lados
 4 trincos de aço de Ø 14 mm
 Cilindro de perfil europeu com lingueta de 15 mm*
 O cilindro acciona o trinco e as línguas (2 voltas)

* Cilindro opcional. Optional cylinder. Canhão optional

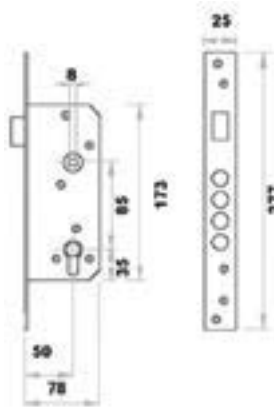

701 · 702			
	Entrada	Ref.	Embalaje
701 latonado	50 mm	10701	6
702 cromo mate	50 mm	10702	6

504

Acabado en latón y cromo brillo en frontal y cerradero
 Picaporte reversible, accionado por llave y manilla por ambos lados (excepto 10509-10510)
 4 bulones de acero de Ø 14 mm
 Cilindro europerfil de latón con sistema de piñón de 10 dientes (sólo 10006-10508)

Forend and striking plate with brass and bright chrome plated finish
 Reversible latch, working key and handle in both sides (except 10509-10510)
 4 steel bolts of Ø 14 mm
 Europrofile cylinder with pinion gear system 10 pins security keys (only 10006-10508)
 Tratamento final no frontal em latão e cromo brilhante
 Trinco reversível, accionado por chave e manípulo de ambos lados (excepto 10509-10510)
 4 trincos de aço de Ø 14 mm
 Cilindro de perfil europeu de latão com sistema de carrete com 10 dentes (solo 10006-10508)

Resbalón anti-tarjeta

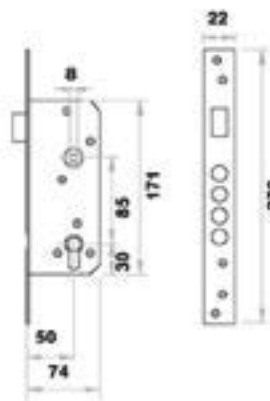

504				
	Entrada	Ref.	Cilindro	Picaporte
latón	50 mm	10006	(30x30)	x
latón	50 mm	10007	-	x
cromo	50 mm	10530	-	x
latón	50 mm	10508	(30x40)	x
latón	50 mm	10509	-	-
cromo	50 mm	10510	-	-

601 · 602

PICAPORTE

Acabado dorado en frontal y cerradero
 Picaporte unificado, válido indistintamente para puertas de paso con picaporte o con picaporte y condensa
 Picaporte reversible
 Frente de 135x20 mm con extremos redondeados y rectos
 Caja mecanismo cerrado)

Forend and striking plate with golden finish
 Dual latchbolt, suitable for passage latch doors and for bedroom or bathroom doors
 Reversible latch
 Forend of 135x20 mm with round or straight edges
 Closed lockcase

Tratamento final no frontal e chapatesta em dourado
 Trinco unificado, vá'ellido indistintamente para portas de entrada com trinco ou com trinco e manípulo de tranca
 Trinco reversível
 Frontal de 135x20 mm com extremidades arredondadas e rectas
 Caixa mecanismo fechada



601

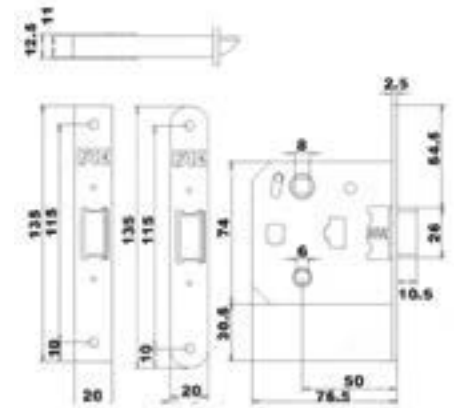

601 · 602			
		Ref.	Embalaje
601 cuadrado	(caja)	10601	50
	(blister)	10651	1

603 · 604

PICAPORTE

Acabado cromo mate en frontal y cerradero
 Picaporte unificado, válido indistintamente para puertas de paso con picaporte o con picaporte y condensa
 Picaporte reversible
 Frente de 135x20 mm con extremos redondeados y rectos
 Caja mecanismo cerrado)

Forend and striking plate with satin chrome plated finish
 Dual latchbolt, suitable for passage latch doors and for bedroom or bathroom doors
 Reversible latch
 Forend of 135x20 mm with round or straight edges
 Closed lockcase

Tratamento final no frontal e chapatesta em cromo aceitado
 Trinco unificado, vá'ellido indistintamente para portas de entrada com trinco ou com trinco e manípulo de tranca
 Trinco reversível
 Frontal de 135x20 mm com extremidades arredondadas e rectas
 Caixa mecanismo fechada



603



604

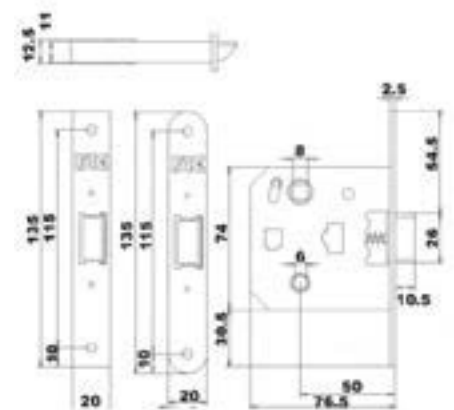

603 · 604			
		Ref.	Embalaje
603 cuadrado	(caja)	10603	50
	(blister)	10653	1
604 redondo	(caja)	10604	50
	(blister)	10654	1

801 · 803

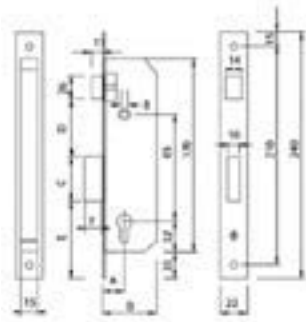

	25	30	35	40	45	50	60	70
A	25	30	35	40	45	50	60	70
B	40	45	50	66	71	76	86	96
C	40	40	40	47	47	47	47	47
D	51	51	51	53	53	53	53	53
E	76	76	76	68	68	68	68	68
F	15	15	15	20	20	20	20	20



801

803

Acabado latonado y cromo brillo en frontal y cerradero
Picaporte reversible, accionado por llave y manilla por ambos lados
El cilindro acciona el picaporte y la palanca

Forend and striking plate with brass plated and bright chrome plated finish

Reversible latch, working key and handle in both sides

Cylinder works latch and deadbolt

Tratamento final no frontal e chapatesta em cromo brilhante

Trinco reversível, accionado por chave e manípulo de ambos lados

O cilindro acciona o trinco e a liedgua

801 · 803			
	Entrada	Ref.	Embalaje
latón	25 mm	10801	6
cromo brillo	25 mm	10821	6
latón	30 mm	10802	6
cromo brillo	30 mm	10822	6
latón	35 mm	10803	6
cromo brillo	35 mm	10823	6
latón	40 mm	10804	6
cromo brillo	40 mm	10824	6
latón	45 mm	10805	6
cromo brillo	45 mm	10825	6
latón	50 mm	10806	6
cromo brillo	50 mm	10826	6
latón	60 mm	10807	6
cromo brillo	60 mm	10827	6
latón	70 mm	10808	6
cromo brillo	70 mm	10828	6

802 · 804

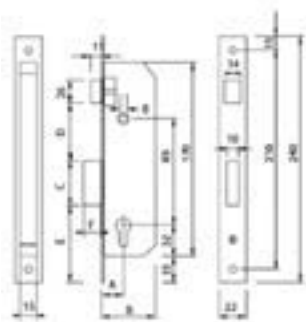

	25	30	35	40	45	50	60	70
A	25	30	35	40	45	50	60	70
B	40	45	50	66	71	76	86	96
C	40	40	40	47	47	47	47	47
D	51	51	51	53	53	53	53	53
E	76	76	76	68	68	68	68	68
F	15	15	15	20	20	20	20	20



802

804

Acabado latonado y cromo brillo en frontal y cerradero
Picaporte reversible, accionado por llave y manilla por ambos lados
El cilindro acciona el picaporte y la palanca (2 vueltas)

Forend and striking plate with brass plated and bright chrome plated finish

Reversible latch, working key and handle in both sides

Cylinder works latch and deadbolt (double throw)

Tratamento final no frontal e chapatesta em cromo brilhante

Trinco reversível, accionado por chave e manípulo de ambos lados

O cilindro acciona o trinco e a liedgua (2 voltas)

802 · 804			
	Entrada	Ref.	Embalaje
latón	25 mm	10811	6
cromo brillo	25 mm	10831	6
latón	30 mm	10812	6
cromo brillo	30 mm	10832	6
latón	35 mm	10813	6
cromo brillo	35 mm	10833	6
latón	40 mm	10814	6
cromo brillo	40 mm	10834	6
latón	45 mm	10815	6
cromo brillo	45 mm	10835	6
latón	50 mm	10816	6
cromo brillo	50 mm	10836	6
latón	60 mm	10817	6
cromo brillo	60 mm	10837	6
latón	70 mm	10818	6
cromo brillo	70 mm	10838	6

480 B

INDIVIDUAL / EN PAREJAS / DOBLE AMAESTRADA

Acabado dorado y cromado
 Gorjas y caja en chapa de acero de 1,5 mm
 Bulones en acero calibrado de Ø 14 mm
 Cerradero en chapa de acero de 2 mm
 Se sirve en unidades y parejas con la misma clave (excepto Mod. 480 B doble amaestrada)
 Apertura de doble intervención (sólo Mod. 480 B doble amaestrado)
 Escudo de latón

Golden and chrome plated finish
 1,5 mm
 1,5 mm steel plate levers and plate box
 14 mm Ø steel bolts with rotating seaths
 2 mm steel plate lock
 Available in units and sets with same pins (except for Mod. 480 B dual master lock)
 Dual control opening (Only Mod. 480 B dual master lock)
 Brass escutcheon

Acabamento em dourado e cromo
 Gorges e caixa em aço de 1,5 mm
 Trincos em aço de Ø 14 mm
 Trancador em aço de 2 mm
 Fornecido em unidades e pares com a mesma chave (exceto fechadura Mod. 480 B dupla amaestrada)
 Abertura de dupla intervenção (Solo Mod. 480 B dupla amaestrada)
 Escudo de latão

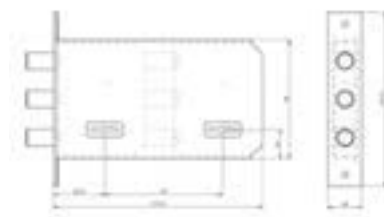
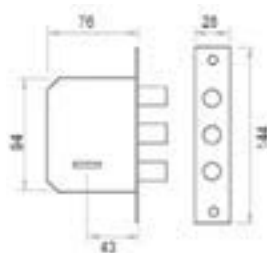
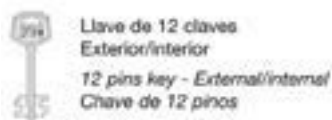

480 B			
		Ref.	Embalaje
dorado	Individual	01178	1
dorado	Pareja	01179	pareja
dorado	Doble amae.	01202	1
cromado	Individual	01199	1
cromado	Pareja	01201	pareja



cerraduras de superponer

RIM LOCKS · FECHADURAS DE SUPERFICIE

FAC



ANTI-IMPRESSIONING

(novedoso sistema que impide la copia por impresión)

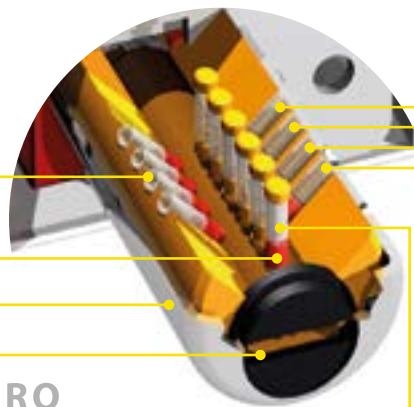

ANTI-TALADRO

(casquillo y disco giratorio en acero carbonitrurado primer pito en acero inoxidable)

ANTI-BUMPING

(8 pitos diábolo flotantes dispuestos en nuevo sistema en V)

ANTI-GANZÚA

(pitos diábolo alternos y pitos diábolo flotantes dispuestos en nuevo sistema en V)

SISTEMA UVE

S 90 AP UVE

SOBREPONER ARTICULADA MULTIPOINTS LOCKS / DE SUPERFICIE ARTICULADA

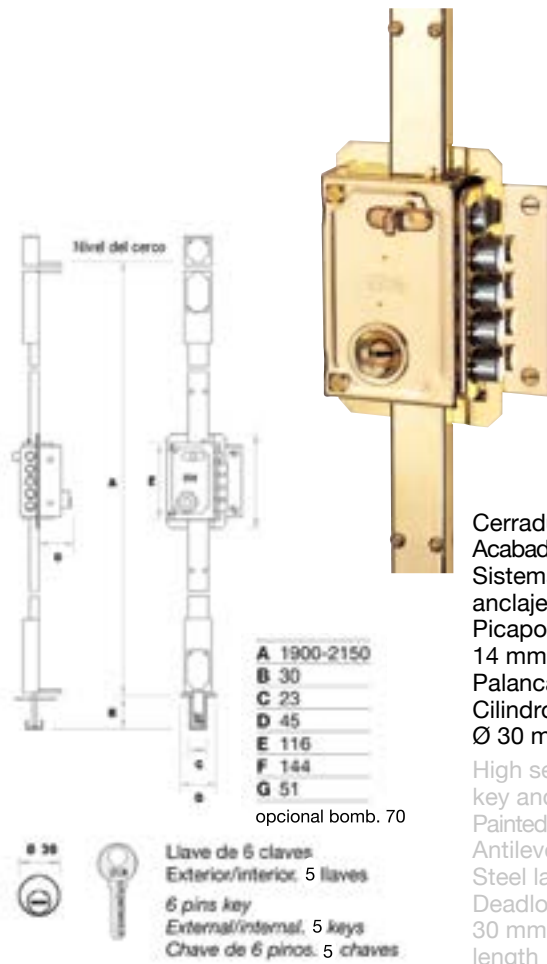

Cerradura multipuntos regulable en altura
Acabado pintado y dorado (opcional cromo)
Sistema anti-palanqueta. 3 puntos de anclaje
Picaporte y 4 pasadores de acero de Ø 14 mm
Palanca bloqueo picaporte
Cilindro protegido de latón de 50 mm y Ø 30 mm
High security multipoints lock with flat key and possibility of height adjustment
Painted and golden finish (cromo optional)
Antilever system. 3 locking points
Steel latch and 4 bolts of Ø 14 mm
Deadlocking latch
30 mm Ø round brass cylinder: 50 mm length

bombillo 50 mm

		Ref.	Embalaje
Pintado	(dcha.)	11033	1
	(izqda.)	11034	1
Dorado	(dcha.)	11035	1
	(izqda.)	11036	1

43

Fechadura multipontos regulável em altura
Acabamento pintado e dourado (opcion cromo)
Sistema anti-trancamento. 3 pontos travando
Sistema de trancamento através de mecanismo de deslizamiento e 4 trincos em aço de Ø 14 mm
Alavanca de bloqueio do trinco
Cilindro de latão de Ø 30 mm e 50 mm de longitude

S 90 P UVE

SOBREPONER RIM LOCK / DE SUPERFICIE

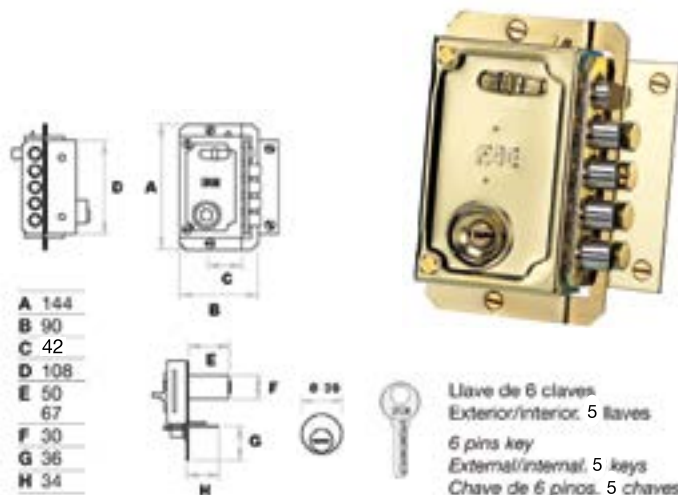

Cerradura de un punto de cierre con llave de puntos
Acabado pintado y dorado
Sistema anti-palanqueta
Picaporte y 4 pasadores de acero de Ø 14 mm
Palanca bloqueo picaporte
Cilindro protegido de latón de 50-70 mm y Ø 30 mm

With security rim lock with flat key
Painted and golden finish
Antilever system
Steel latch and 4 bolts of Ø 14 mm

Deadlocking latch
30 mm Ø round brass cylinder:
50-70 mm length

Fechadura de superficie com chave de segurança
Acabamento pintado e dourado
Sistema anti-trancamento
Sistema de trancamento através de mecanismo de deslizamiento e 4 trincos em aço de Ø 14 mm
Alavanca de bloqueio do trinco
Cilindro de latão de Ø 30 mm e 50-70 mm de longitude

bombillo 50 mm

		Ref.	Embalaje
Pintado	(dcha.)	11019	1
	(izqda.)	11020	1
Cromado	(dcha.)	11021	1
	(izqda.)	11022	1
Dorado	(dcha.)	11023	1
	(izqda.)	11024	1

bombillo 70 mm

		Ref.	Embalaje
Pintado	(dcha.)	11518	1
	(izqda.)	11519	1
Cromado	(dcha.)	11520	1
	(izqda.)	11521	1
Dorado	(dcha.)	11522	1
	(izqda.)	11523	1

S 90

SOBREPONER RIM LOCK / DE SUPERFICIE



Cerradura de un punto de cierre con llave dentada

Acabado pintado y dorado

Sistema anti-palanqueta

Picaporte y 4 pasadores de acero de Ø 14 mm

Palanca bloqueo picaporte

Cilindro de latón de 50-70 mm y Ø 27 mm

High security rim lock with 7 pins jagged tumbler key

Painted and golden finish

Antilever system

Steel latch and 4 bolts of Ø 14 mm

Deadlocking latch

27 mm Ø round brass cylinder:

50-70 mm length

Fechadura de superficie com chave dentada de 7 pinos

Acabamento pintado e dourado

Sistema anti-trancamento

Sistema de trancamento através de mecanismo de deslizamiento e 4 trincos em aço de Ø 14 mm

Alavanca de bloqueio do trinco

Cilindro de latão de Ø 27 mm e 50-70 mm de longitude

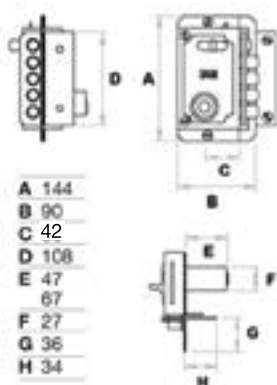

- A 144
- B 90
- C 42
- D 108
- E 47
- F 67
- G 27
- H 34



Llave de 7 claves
Exterior/interior, 3 llaves
7 pins key
External/internal, 3 keys
Chave de 7 pinos, 3 chaves

bombillo 50 mm

	Ref.	Embalaje
Pintado	(dcha.) 11001	6
	(izqda.) 11002	6
Dorado	(dcha.) 11005	6
	(izqda.) 11006	6

bombillo 70 mm

	Ref.	Embalaje
Pintado	(dcha.) 11500	1
	(izqda.) 11501	1
Dorado	(dcha.) 11504	1
	(izqda.) 11505	1

S 90 C

SOBREPONER RIM LOCK / DE SUPERFICIE



Cerradura de un punto de cierre con llave dentada

Acabado pintado y dorado

Sistema anti-palanqueta

5 pasadores de acero de Ø 14 mm

Cilindro de latón de 50-70 mm y Ø 27 mm

High security rim lock with 7 pins jagged tumbler key

Painted and golden finish

Antilever system

5 bolts of Ø 14 mm

27 mm Ø round brass cylinder:

50-70 mm length

Fechadura de superficie com chave dentada de 7 pinos

Acabamento pintado e dourado

Sistema anti-trancamento

Sistema de trancamento através de mecanismo de deslizamiento e 5 trincos em aço de Ø 14 mm

Cilindro de latão de Ø 27 mm e 50-70 mm

de longitude

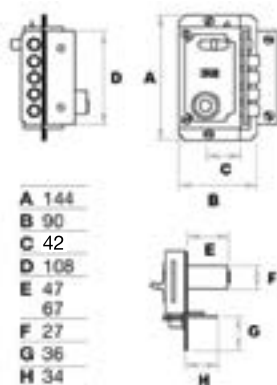

- A 144
- B 90
- C 42
- D 108
- E 47
- F 67
- G 27
- H 34



Llave de 7 claves
Exterior/interior, 3 llaves
7 pins key
External/internal, 3 keys
Chave de 7 pinos, 3 chaves

bombillo 50 mm

	Ref.	Embalaje
Pintado	(dcha.) 11007	6
	(izqda.) 11008	6
Dorado	(dcha.) 11011	6
	(izqda.) 11012	6

bombillo 70 mm

	Ref.	Embalaje
Pintado	(dcha.) 11506	1
	(izqda.) 11507	1
Dorado	(dcha.) 11510	1
	(izqda.) 11511	1

S 90 CP

SOBREPONER

RIM LOCK / DE SUPERFICIE



Cerradura de un punto de cierre con llave de puntos
Acabado pintado y dorado
5 pasadores de acero de Ø 14 mm
Cilindro protegido de latón de 50-70 mm y Ø 30 mm
Sistema anti-palanqueta

High security rim lock with flat key
Painted and golden finish
5 steel bolts of Ø 14 mm
30 mm Ø round brass cylinder:
50-70 mm length
Antilever system

Fechadura de segurança com chave dentada de 7 pinos
Acabamento pintado e dourado
Sistema de trancamento através de 5 trincos em aço de Ø 14 mm
Cilindro de latão de Ø 30 mm e 50-70 mm de longitude
Sistema anti-trancamento

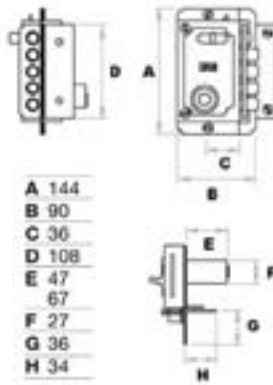

Llave de 6 claves
Exterior/interior, 3 llaves
6 pins key
External/internal, 3 keys
Chave de 6 pinos, 3 chaves

bombillo 50 mm			
	Ref.	Embalaje	
Pintado	(dcha.)	11025	1
	(izqda.)	11026	1
Dorado	(dcha.)	11029	1
	(izqda.)	11030	1

bombillo 70 mm			
	Ref.	Embalaje	
Pintado	(dcha.)	11524	1
	(izqda.)	11525	1
Dorado	(dcha.)	11528	1
	(izqda.)	11529	1

45

Cerradura de un punto de cierre con llave dentada
Acabado pintado
Picaporte y palanca
Cilindro de latón de 50 mm de longitud

1 locking point with jagged key
Painted finish
Latch and deadbolt
50 mm length brass cylinder

Fechadura de 1 ponto de trinco com chave dentada
Acabamento pintado
Trinco e tranca
Cilindro de latão com 50 mm de longitude



S 2000

SOBREPONER

RIM LOCK / DE SUPERFICIE

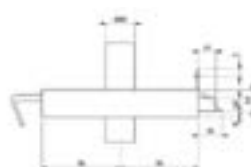
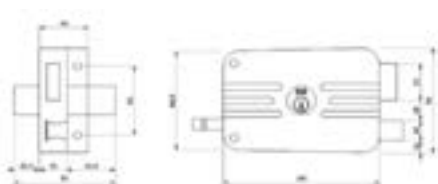

entrada 60 mm			
	Ref.	Embalaje	
Pintado	(dcha.)	34202	1
	(izqda.)	34206	1

entrada 70 mm			
	Ref.	Embalaje	
Pintado	(dcha.)	34203	1
	(izqda.)	34207	1

MB 86 PP UVE

MULTIBARRA 7 PASADORES MULTIBAR 7 BOLTS / MULTIBAR 7 PARAFUSOS

Cilindro de latón con llave plana con pomo por el interior

Por el exterior funciona con la llave quedando las barras siempre en disposición de utilizarlas con el pomo desde el interior

Brass cylinder with fac dimple key with inside knob It works inside with the hand, pressing the button in the center of the knob and turning in order to shift the latch and turn or throw in the bars. On the outside, it works with the key, with the bars always arranged for use with the knob from the inside

Cilindro de latão de segurança com monípulo no interior

E accionado interiormente com a mano, utilizansose o manípulo moviendo as linguetas. Pelo exterior funciona com a chave podendo utilizar-se o manípulo desde o interior

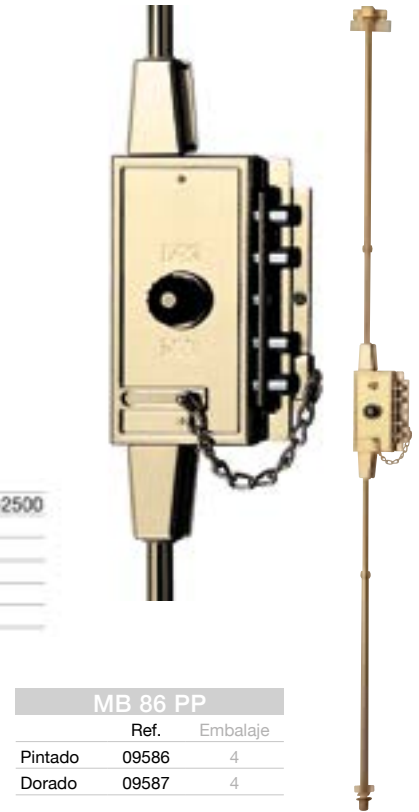
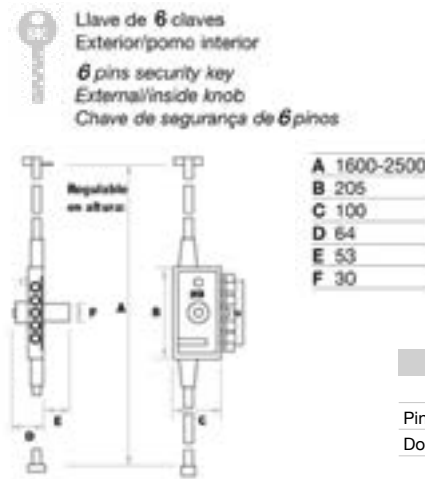

MB 86 PP		
	Ref.	Embalaje
Pintado	09586	4
Dorado	09587	4

MB 86

Acabado pintado y dorado
Cerradura con carcasa fabricada en acero de 2 mm
Cerraderos de acero de 2,5 mm
Cilindro de latón de 50 mm de longitud y Ø 30 mm con protector de acero tratado
4 pasadores de acero calibrado de Ø 16 mm
Retenedor: cadena soldada con eslabón de Ø 3 mm
Tubos telescópicos de acero

Painted and golden finish
2 mm lock casing cover
2,5 mm steel striking plate
Ø 30 mm brass cylinder: 50 mm length
4 steel bolts of Ø 16 mm
Ø 3 mm link welded chain
Telescopic tubes

Acabamento pintado e dourado
Fechadura com caixa em aço de 2 mm
Trancador em aço de 2,5 mm
Cilindro em latão de 50 mm de longitude e Ø 30 mm
4 trincos em aço de Ø 16 mm
Corrente de segurança com aneis de 3 mm de espessura
Tubos telescópicos em aço

Cilindro de latón con llave plana por el interior
Se acciona interior y exteriormente con la llave, quedando siempre en barras fijas

Brass cylinder with fac dimple key
It works inside and outside with the key always in fixed bars

Cilindro de latão de segurança com chave interior

É accionado interiormente e exteriormente com a chave ficando sempre as trancas fixas

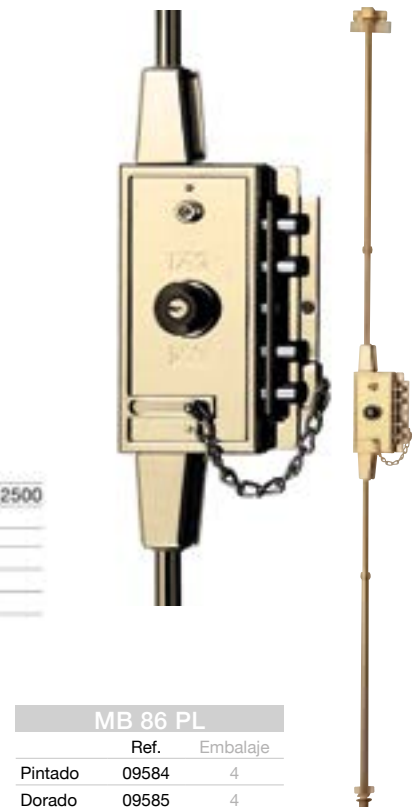
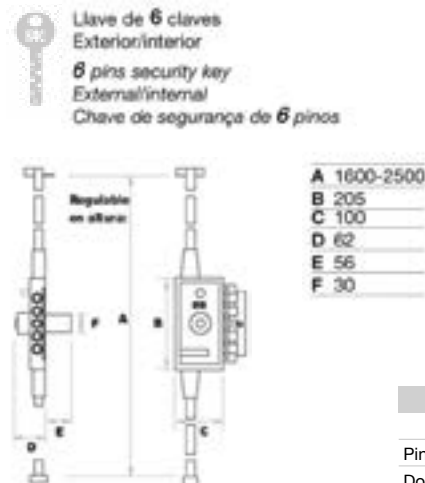

MB 86 PL		
	Ref.	Embalaje
Pintado	09584	4
Dorado	09585	4

MBA PP UVE

MULTIBARRA 9 PASADORES MULTIBAR 9 BOLTS / MULTIBAR 9 PARAFUSOS



A 1655
B 205
C 100
D 64
E 53
F 30

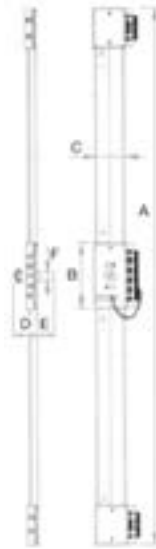

 Llave de 6 claves
 Exterior/pomo interior
 6 pins security key
 External/inside knob
 Chave de segurança de 6 pinos

MBA PP		
	Ref.	Embalaje
Pintado	09591	4
Cromo satinado	09593	4

Acabado pintado y cromo satinado
 Cerradura con carcasa fabricada en acero de 2 mm
 Cerraderos de acero de 2,5 mm
 Cilindro de latón con llave plana, de 50 mm de longitud y Ø 30 mm con protector de acero tratado.
 Por el exterior funciona con llave, quedando las barras siempre en disposición de utilizarlas con el pomo por el interior.

Pasadores de acero calibrado de Ø 16 mm
 Retenedor: cadena soldada con eslabón de Ø 3 mm

Painted and satin chromed finish
 Brass cylinder with fac dimple key with inside knob It works inside with the hand, pressing the button in the center of the knob and turning in order to shift the latch and turn or throw in the bars. On the outside, it works inside with the hand, pressing the button in the center of the knob and turning in order to with the key, with the bolts always arranged for use with the knob from the inside. Ø 30 mm brass cylinder: 50 mm length
 Steel bolts of Ø 16 mm
 Ø 3 mm link welded chain

Acabamento pintado e cromado mate
 Cilindro de latão de segurança com manípulo no interior E accionado interiormente com a mano, utilizansose o manípulo moviendo as linguetes. Pelo exterior funciona com a chave podendo utilizar-se o manípulo desde o interior.
 Cilindro em latão de 50 mm de longitude e Ø 30 mm
 Trincos em aço de Ø 16 mm
 Corrente de segurança com aneis de 3 mm de espessura

47

MBA PL UVE

MULTIBARRA 9 PASADORES MULTIBAR 9 BOLTS / MULTIBAR 9 PARAFUSOS



A 1655
B 205
C 100
D 58
E 53
F 30

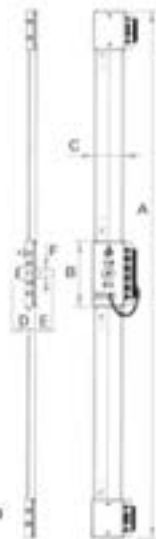

 Llave de 6 claves
 Exterior/interior
 6 pins security key
 External/internal
 Chave de segurança de 6 pinos

MBA PL		
	Ref.	Embalaje
Pintado	09590	4
Cromo satinado	09592	4

Acabado pintado y cromo satinado
 Cerradura con carcasa fabricada en acero de 2 mm
 Cerraderos de acero de 2,5 mm
 Cilindro de latón con llave plana, de 50 mm de longitud y Ø 30 mm con protector de acero tratado
 Se acciona interior y exteriormente con la llave, quedando siempre en barras fijas Pasadores de acero calibrado de Ø 16 mm
 Retenedor: cadena soldada con eslabón de Ø 3 mm

Painted and satin chromed finish
 2 mm lock casing cover
 2,5 mm steel striking plate
 Ø 30 mm brass cylinder: 50 mm length
 Steel bolts of Ø 16 mm
 Ø 3 mm link welded chain

Acabamento pintado e cromado mate
 Fechadura com caixa em aço de 2 mm
 Trancador em aço de 2,5 mm
 Cilindro em latão de 50 mm de longitude e Ø 30 mm
 Trincos em aço de Ø 16 mm
 Corrente de segurança com aneis de 3 mm de espessura

MB PP UVE

MULTIBARRA 5 PASADORES

5 BOLTS / 5 PARAFUSOS

Cilindro de latón con llave plana con pomo por el interior
 Por el exterior funciona con la llave quedando los bulones siempre en disposición de utilizarlas con el pomo desde el interior

Brass cylinder with fac dimple key with inside knob
 It works inside with the hand, pressing the button in the center of the knob and turning in order to shift the latch and turn or throw in the bars. On the outside, it works inside with the hand, pressing the button in the center of the knob and turning in order to with the key, with the bolts always arranged for use with the knob from the inside

Cilindro de latão de segurança com monípulo no interior
 É accionado interiormente com a mão, utilizansose o manípulo moviendo as linguetes. Pelo exterior funciona com a chave podendo utilizar-se o manípulo desde o interior

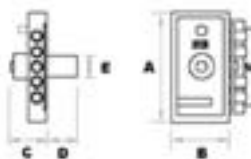

A 205
 B 100
 C 64
 D 53
 E 30

MB

Acabado pintado y dorado
 Cerradura con carcasa fabricada en acero de 2 mm
 Cerraderos de acero de 2,5 mm
 Cilindro de latón de 50 mm de longitud y Ø 30 mm con carcasa de acero tratado
 4 pasadores de acero calibrado de Ø 16 mm
 Retenedor: cadena soldada con eslabón de Ø 3 mm

Painted and golden finish
 2 mm lock casing cover
 2,5 mm steel striking plate
 Ø 30 mm brass cylinder: 50 mm length
 4 steel bolts of Ø 16 mm
 Ø 3 mm link welded chain

Acabamento pintado e dourado
 Fechadura com caixa em aço de 2 mm
 Trancador em aço de 2,5 mm
 Cilindro em latão de 50 mm de longitude e Ø 30 mm
 4 trincos em aço de Ø 16 mm
 Corrente de segurança com aneis de 3 mm de espessura



Llave de 6 claves
 Exterior/pomo interior
 6 pins security key
 External/inside knob
 Chave de segurança de 6 pinos

MB PP

	Ref.	Embalaje
Pintado	09579	4
Dorado	09595	4

MB PL UVE

MULTIBARRA 5 PASADORES

5 BOLTS / 5 PARAFUSOS

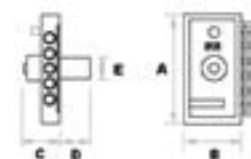

A 205
 B 100
 C 62
 D 56
 E 30

Cilindro de latón con llave plana por el interior
 Se acciona interior y exteriormente con la llave, quedando siempre en bulones fijos

Brass cylinder with fac dimple key with inside and outside knob
 It works inside and outside with the key always in fixed bolts

Cilindro de latão de segurança com monípulo interior e exterior
 É accionado interiormente e exteriormente com a chave ficando sempre as linguetes fixos



Llave de 6 claves
 Exterior/pomo interior
 6 pins security key
 External/inside knob
 Chave de segurança de 6 pinos

MB PL

	Ref.	Embalaje
Pintado	09578	4
Dorado	09594	4



cerraduras de embutir en perfil metálico

METALLIC MORTICE LOCKS · FECHADURAS PARA PORTA METÁLICA

FAC



7001

PICAPORTE LATCH ONLY / TRINCO

Frontal y cerradero de acero inoxidable
 Picaporte reversible accionable por medio de llave o manilla
 Cuadradillo para manilla de 8 mm
 Picaporte niquelado
 Cilindro europerfil cromado de llave dentada. 3 llaves. Leva de 13,5 mm)
 Stainless steel forend and striking plate
 Adjustable latch actioned by key or handle
 8 mm square for handle
 Nickel-plated latch
 Chrome plated europrofile cylinder with jagged key. 3 keys. 13,5 mm cam
 Frontal e trancador em aço inoxidável
 Trinco reversível accionado por chave ou manípulo
 Eixo cúbico para manípulo de 8 mm
 Trinco niquelado
 Cilindro de perfil europeo cromado de chave dentada. 3 chaves. Lleva de 13,5 mm



7001		
	Ref.	Embalaje
20 mm	29022	6
25 mm	29023	6
30 mm	29024	6



51

7002

PICAPORTE Y PALANCA LATCH & DEADBOLT / TRINCO E LÍNGUA

Frontal y cerradero de acero inoxidable
 Palanca deslizante de acero
 Picaporte reversible accionable por medio de llave o manilla
 Cuadradillo para manilla de 8 mm
 Picaporte y palanca niquelados
 Cilindro europerfil cromado de llave dentada. 3 llaves. Leva de 13,5 mm)
 Stainless steel forend and striking plate
 Steel sliding deadbolt
 Adjustable latch actioned by key or handle
 8 mm square for handle
 Nickel-plated latch and deadbolt
 Chrome plated europrofile cylinder with jagged key. 3 keys. 13,5 mm cam
 Frontal e trancador em aço inoxidável
 Tranca deslizante em aço
 Trinco reversível accionado por chave ou manípulo
 Eixo cúbico para manípulo de 8 mm
 Trinco e tranca niquelado
 Cilindro de perfil europeo cromado de chave dentada. 3 chaves. Lleva de 13,5 mm

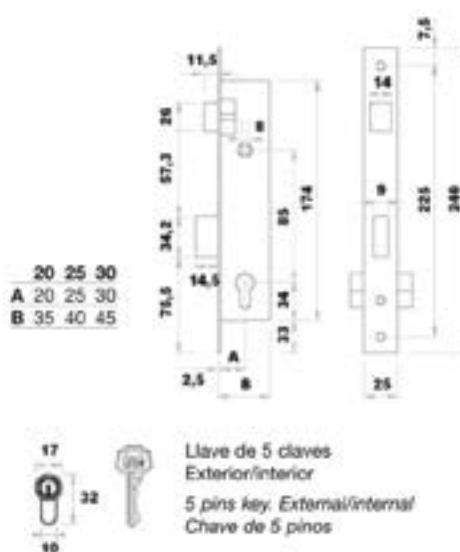

7002		
	Ref.	Embalaje
20 mm	29025	6
25 mm	29026	6
30 mm	29027	6



7003

PICAPORTE Y GANCHO BASCULANTE LATCH & HOOK / TRINCO E GANCHO

Frontal y cerradero de acero inoxidable
 Gancho construido con chapas de acero con sistema antipalanca
 Picaporte reversible accionable por medio de llave o manilla
 Cuadradillo para manilla de 8 mm
 Picaporte y gancho niquelados
 Cilindro europerfil cromado de llave dentada.
 3 llaves. Leva de 13,5 mm
 Escudo antimordaza

Stainless steel forend and striking plate
 Hook made of laminated steel with anti-lever system
 Adjustable latch actioned by key or handle
 8 mm square for handle
 Nickel-plated latch and hook
 Chrome plated europrofile cylinder with jagged key. 3 keys. 13,5 mm cam
 Escutcheon

Frontal e trancador em aço inoxidável
 Gancho fabricado com chapas em aço com sistema anti-trancamento
 Trinco reversível accionado por chave e manípulo
 Eixo cúbico para manípulo de 8 mm
 Trinco e gancho niquelado
 Cilindro de perfil europeu cromado de chave dentada. 3 chaves. Leva de 13,5 mm
 Escudo protector anti-perfuração

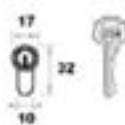
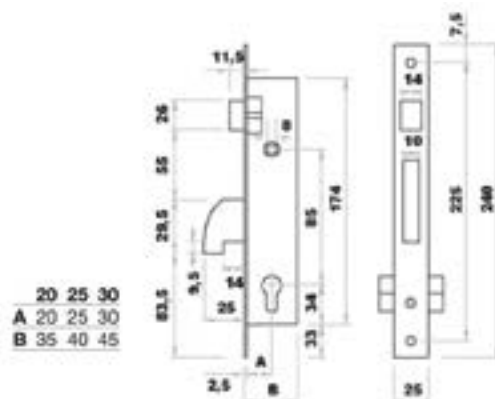

Llave de 5 claves
 Exterior/interior
 5 pins key. External/interior
 Chave de 5 pinos

7003		
	Ref.	Embalaje
20 mm	29028	6
25 mm	29029	6
30 mm	29030	6

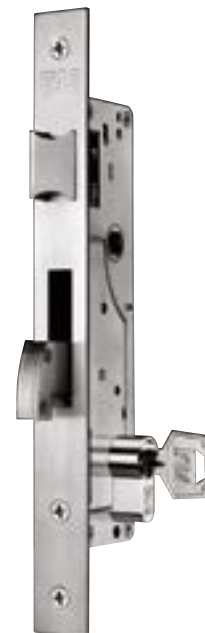

7006

GANCHO BASCULANTE HOOK ONLY / GANCHO BASCULANTE

Frontal y cerradero de acero inoxidable
 Gancho construido con chapas de acero con sistema antipalanca
 Gancho niquelado
 Cilindro europerfil cromado de llave dentada. 3 llaves. Leva de 13,5 mm
 Escudo antimordaza

Stainless steel forend and striking plate
 Hook made of laminated steel with anti-lever system
 Nickel-plated hook
 Chrome plated europrofile cylinder with jagged key. 3 keys. 13,5 mm cam
 Escutcheon

Frontal e trancador em aço inoxidável
 Gancho fabricado com chapas em aço com sistema anti-trancamento
 Gancho niquelado
 Cilindro de perfil europeu cromado de chave dentada. 3 chaves. Leva de 13,5 mm
 Escudo protector anti-perfuração

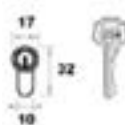
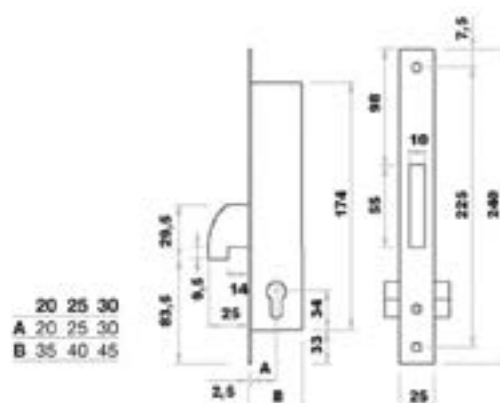

Llave de 5 claves
 Exterior/interior
 5 pins key. External/interior
 Chave de 5 pinos

7006		
	Ref.	Embalaje
20 mm	29037	6
25 mm	29038	6
30 mm	29039	6



7008

PICAPORTE Y PALANCA BASCULANTE LATCH & HOOK / TRINCO E TRANCA BASCULANTE

Frontal y cerradero de acero inoxidable
Paletón construido con chapas de acero con sistema antipalanca
Picaporte reversible accionable por medio de llave o manilla
Cuadradillo para manilla de 8 mm
Picaporte y paletón niquelados
Cilindro europerfil cromado de llave dentada. 3 llaves. Leva de 13,5 mm
Escudo antimordaza

Stainless steel forend and striking plate
Hook made of laminated steel with anti-lever system
Adjustable latch actoned by key or handle 8 mm square for handle
Nickel-plated latch and hook
Chrome plated europrofile cylinder with jagged key. 3 keys. 13,5 mm cam
Escutcheon

Frontal e trancador em aço inoxidável
Gancho fabricado com chapas em aço com sistema anti-trancamento
Trinco reversível accionado por chave ou manípulo
Eixo cúbico para manípulo de 8 mm
Trinco e gancho niquelado
Cilindro de perfil europeo cromado de chave dentada. 3 chaves. Lleva de 13,5 mm
Escudo protector anti-perfuração

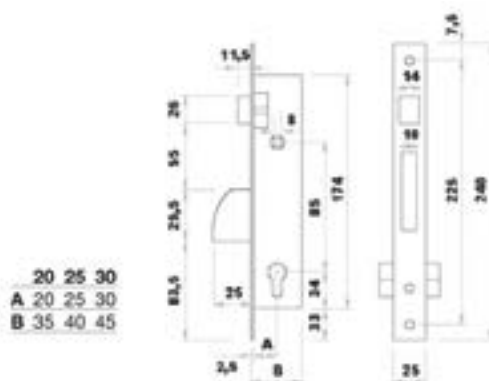

20 25 30
A 20 25 30
B 35 40 45



Llave de 5 clavos
Exterior/interior
5 pins key. External/internal
Chave de 5 pinos

7006		
	Ref.	Embalaje
20 mm	29043	6
30 mm	29045	6







cerraduras eléctricas y electrónicas

ELECTRIC AND ELECTRONIC LOCKS
FECHADURAS ELÉTRICAS E ELETRÔNICAS

FAC



SIN PULSADOR

ELÉCTRICA

WITHOUT PUSH BUTTON / SEM PULSADOR

Entrada regulable de 50 mm a 80 mm

Picaporte autoblocante

Placa de protección para la cerradura y cerradero

Tensión de 12V CA 2,3

Amperios

Llave dentada de 5 claves

Adjustable backset from 50 to 80 mm

Self-locking latch and bolt

Mortice locks and keep plate support

Feeding voltage 12V CA 2,3

Amperes

5 pins jagged key

Entrada ajustável de 50 mm a 80 mm

Trinco autoblocante

Placa de proteção para a fechadura e trancador

Tensão de 12V CA 2,3 Ampères

Chave dentada de 5 pinos

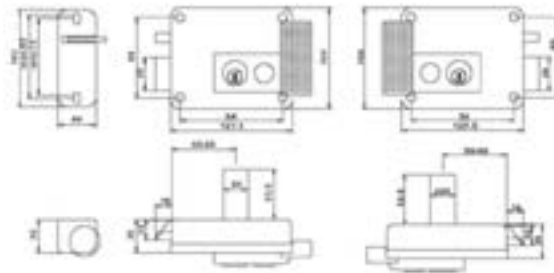

A 127,5
B 106
C 35



Llave de 5 claves
5 pins key
Chave de 5 pinos



sin pulsador

		Ref.	Embalaje
Interna	(derecha)	34005	1
	(izquierda)	34007	1

57

CON PULSADOR

ELÉCTRICA

WITH PUSH BUTTON / COM PULSADOR

Entrada regulable de 50 mm a 80 mm

Picaporte autoblocante

Placa de protección para la cerradura y cerradero

Tensión de 12V CA 2,3

Amperios

Llave dentada de 5 claves

Adjustable backset from 50 to 80 mm

Self-locking latch and bolt

Mortice locks and keep plate support

Feeding voltage 12V CA 2,3

Amperes

5 pins jagged key

Entrada ajustável de 50 mm a 80 mm

Trinco autoblocante

Placa de proteção para a fechadura e trancador

Tensão de 12V CA 2,3 Ampères

Chave dentada de 5 pinos

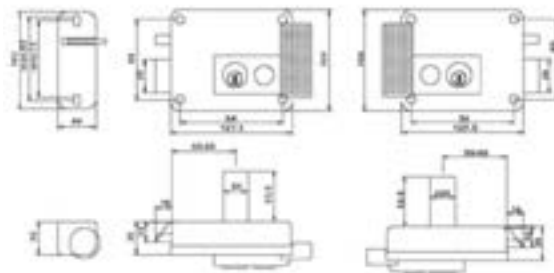

A 127,5
B 106
C 35



Llave de 5 claves
5 pins key
Chave de 5 pinos



con pulsador

		Ref.	Embalaje
Interna	(derecha)	34006	1
	(izquierda)	34008	1



Pantalla táctil de alta sensibilidad y retroiluminada
 Diseño de alta calidad con cristal templado
 Sensor de detección anti-incendio
 Tecnología preventiva de descarga electrostática (ESD)
 Posibilidad de cambio de combinación
 Alarma de entrada no autorizada

Highly sensitive and backlit touch screen
 High quality design in tempered glass
 Anti-fire detection sensor
 Preventive electrostatic discharge technology (ESD)
 Possibility of changing the password
 Non authorized entry alarm

Ecrã táctil de alta sensibilidade e retroiluminado
 Desenho de alta qualidade com cristal temperado
 Sensor de detecção anti-incêndio
 Tecnologia preventiva de descarga electrostática (ESD)
 Possibilidade de alteração de combinação
 Alarme de entrada não autorizada



A 68,7
B 175,1
C 20,1
D 31,5

samsung	
Ref.	Embalaje
39001	1



cerraduras de garaje

GARAGE LOCKS · FECHADURAS DO GARAGE

FAC



DERECHA E IZQUIERDA

RIGHT & LEFT / DIREITA E ESQUERDA GARAJE



CILINDRO EXT. e INT.

EXT. and INT. CYLINDER

CANHAO EXT. e INT.

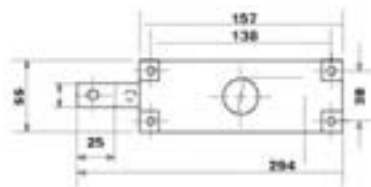

derecha e izquierda

		Ref.	Embalaje
Plana	(derecha)	35001	1
	(izquierda)	35003	1
	(derecha - izquierda)	35007	1
Plegada	(derecha)	35002	1
	(izquierda)	35004	1
	(derecha - izquierda)	35008	1

GARAJE

Cilindro de vuelta sencilla y 3 claves
Suministrada con 2 llaves
niqueladas, sin barras

Las versiones con cierre directo,
plegado, alargado, se suministran
con bulones de 6 mm en todos los
modelos

Caja y componentes zincados

Single turn 3 pin cylinder
Supplied with 2 nickel plated keys,
without bars

Straight, folded and lengthened
locking versions are supplied with
6 mm bolts in all models

Rustproof zinc-plated box and
components

Canhão de volta simples e 3 pinos
Fornecida com 2 chaves niqueladas,
sem barras

As versões com fecho directo,
dobrado e alargado são fornecidas
com trincos de 6 mm em todos os
modelos

Caixa e componentes zincados



DOUBLE / DUPLA GARAJE

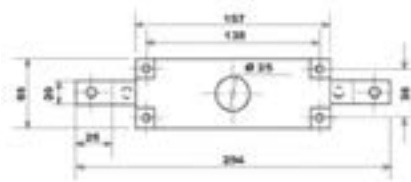

doble

	Ref.	Embalaje
Plana	35005	1
Plana MC	35205	1

VERTICAL

VERTICAL / VERTICAL GARAJE

CILINDRO EXT.

EXT. CYLINDER

CANHAO EXT.

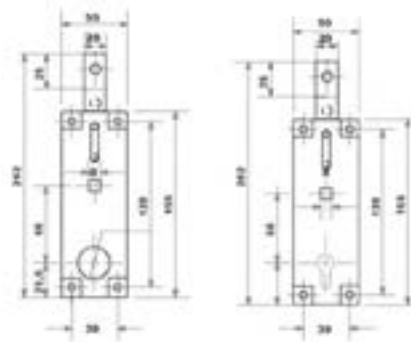

vertical

	Ref.	Embalaje
Cilindro redondo (fijo)	35101	1
Cilindro europa perfil (opcional)	35104	1





cilindros de perfil europeo

EUROPROFILE CYLINDERS
CANHAOS DE PERFIL EUROPEO

FAC

LLAVE DENTADA (F)

JAGGED KEY / CHAVE DENTADA CILINDROS

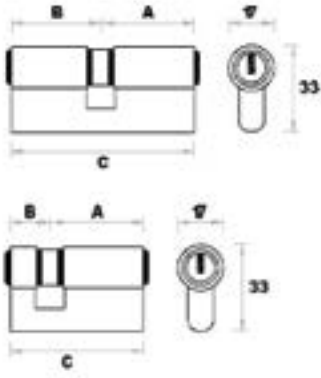
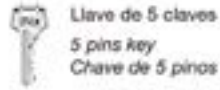

Acabado de latón, níquel y níquel satinado
Disponibles en leva de 13,5 y 15 mm

Brass, nickel and satin nickel finish
Available in 13,5 and 15 mm cam

Acabamento em latão, níquel e níquel acetinado
Disponíveis em leva de 13,5 e 15 mm

*MC Estos modelos pueden ser suministrados con la misma llave
These models are available with the same key
Estes modelos podem ser fornecidos com a mesma combinação

		leva 15 mm (5 llaves)					
			C	A	B	Ref.	Emb.
60F	Latón	(caja)	60	30	30	23029	12
		(blister)	60	30	30	23329	15
	Níquel	(caja)	60	30	30	23045	12
		(blister)	60	30	30	23345	15
70F	Latón	(caja)	70	30	40	23030	12
		(blister)	70	30	40	23330	15
	Níquel	(caja)	70	30	40	23046	12
		(blister)	70	30	40	23346	15
71F	Latón	(caja)	70	35	35	23031	12
		(blister)	70	35	35	23331	15
	Níquel	(caja)	70	35	35	23047	12
		(blister)	70	35	35	23347	15
75F	Níquel	(caja)	75	30	45	23061	12
80F	Latón	(caja)	80	30	50	23032	12
		(caja)	80	30	50	23048	12
81F	Latón	(caja)	80	40	40	23033	12
		(blister)	80	40	40	23333	15
	Níquel	(caja)	80	40	40	23049	12
		(blister)	80	40	40	23349	15
60F MC*	Latón	(caja)	60	30	30	23034	12
		(caja)	60	30	30	23050	12
70F MC*	Latón	(caja)	70	30	40	23035	12
		(caja)	70	30	40	23051	12
71F MC*	Latón	(caja)	70	35	35	23036	12
		(caja)	70	35	35	23052	12

		leva 13,5 mm (5 llaves)					
			C	A	B	Ref.	Emb.
40F	Latón	(caja)	40	30	10	23001	12
		(blister)	40	30	10	23301	15
	Níquel	(caja)	40	30	10	23015	12
		(blister)	40	30	10	23315	15
60F	Latón	(caja)	60	30	30	23002	12
		(blister)	60	30	30	23302	15
	Níquel	(caja)	60	30	30	23016	12
		(blister)	60	30	30	23316	15
70F	Latón	(caja)	70	30	40	23003	12
		(blister)	70	30	40	23303	15
	Níquel	(caja)	70	30	40	23017	12
		(blister)	70	30	40	23317	15
71F	Latón	(caja)	70	35	35	23004	12
		(blister)	70	35	35	23304	15
	Níquel	(caja)	70	35	35	23018	12
		(blister)	70	35	35	23318	15
60F MC*	Latón	(caja)	60	30	30	23005	12
	Níquel	(caja)	60	30	30	23019	12
70F MC*	Latón	(caja)	70	30	40	23006	12
	Níquel	(caja)	70	30	40	23020	12
71F MC*	Latón	(caja)	70	35	35	23007	12
	Níquel	(caja)	70	35	35	23021	12

		leva 15 mm (3 llaves)					
			C	A	B	Ref.	Emb.
65F	Latón	(caja)	65	30	35	23759	12
		Níquel sat.	(caja)	65	30	35	23709
70F	Latón	(caja)	70	30	40	23760	12
		Níquel sat.	(caja)	70	30	40	23710
	Níquel sat.	(caja)	70	35	35	23765	12
		Níquel sat.	(caja)	70	35	35	23715
75F	Níquel sat.	(caja)	75	30	45	23711	12
80F	Latón	(caja)	80	30	50	23762	12
		Níquel sat.	(caja)	80	30	50	23712
	Latón	(caja)	80	35	45	23763	12
		Níquel sat.	(caja)	80	40	40	23766
	Níquel sat.	(caja)	80	30	50	23712	12
		Níquel sat.	(caja)	80	35	45	23713
	Níquel sat.	(caja)	80	40	40	23716	12
		Níquel sat.	(caja)	80	40	40	23716
90F	Latón	(caja)	90	35	55	23764	12
		Níquel sat.	(caja)	90	45	45	23768
100F	Latón	(caja)	100	30	70	23770	12



anti-taladro
ANTI-DRILLING / ANTI-BERBEQUIM

CILINDRO PRO llave dentada (F)

JAGGED KEY / CHAVE DENTADA (leva de 15 mm)

Por cada entrada en tambor o rotor, primera línea de pitones anti-taladro de acero endurecido (60 HRC)
First line with anti-drilling hardened steel pins (60 HRC)
Primeira linha com anti-berbequim pins em aço endurecido (60 HRC)

Barras de acero endurecido anti-taladro
Anti-drilling hardened steel bars
Anti-berbequim barra em aço endurecido

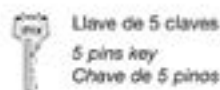
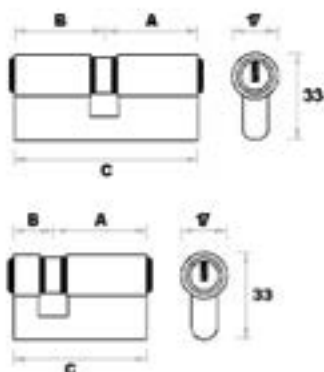

		leva 13,5 mm (5 llaves)					
			C	A	B	Ref.	Emb.
60F	Níquel sat.	(caja)	60	30	30	23116	12

		leva 15 mm (5 llaves)					
			C	A	B	Ref.	Emb.
60F	Latón	(caja)	60	30	30	23129	12
	Níquel sat.	(caja)	60	30	30	23145	12

LLAVE DE PUNTOS (P)

SECURITY KEY / CHAVE SEGURANÇA CILINDROS



Llave de puntos de 6 claves
6 pins flat key
Chave de pontos de 6 pinos



Tarjeta de seguridad
Security card
Cartão de segurança

		leva 13,5 mm (5 llaves)					
			C	A	B	Ref.	Emb.
40P	Latón	(caja)	40	30	10	23008	12
	Níquel	(caja)	40	30	10	23022	12
60P	Latón	(caja)	60	30	30	23009	12
		(blister)	60	30	30	23309	15
	Níquel	(caja)	60	30	30	23023	12
		(blister)	60	30	30	23323	15
70P	Latón	(caja)	70	30	40	23010	12
		(blister)	70	30	40	23310	15
	Níquel	(caja)	70	30	40	23024	12
		(blister)	70	30	40	23324	15
71P	Latón	(caja)	70	35	35	23011	12
		(blister)	70	35	35	23311	15
	Níquel	(caja)	70	35	35	23025	12
		(blister)	70	35	35	23325	15
60P MC*	Latón	(caja)	60	30	30	23012	12
	Níquel	(caja)	60	30	30	23026	12
70P MC*	Latón	(caja)	70	30	40	23013	12
	Níquel	(caja)	70	30	40	23027	12
71P MC*	Latón	(caja)	70	35	35	23014	12
	Níquel	(caja)	70	35	35	23028	12

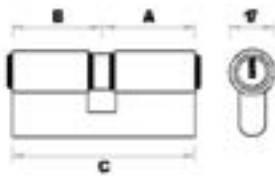
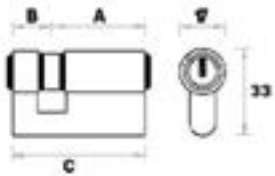

		leva 15 mm (5 llaves)					
			C	A	B	Ref.	Emb.
60P	Latón	(caja)	60	30	30	23037	12
		(blister)	60	30	30	23337	15
	Níquel	(caja)	60	30	30	23053	12
		(blister)	60	30	30	23353	15
70P	Latón	(caja)	70	30	40	23038	12
		(blister)	70	30	40	23338	15
	Níquel	(caja)	70	30	40	23054	12
		(blister)	70	30	40	23354	15
71P	Latón	(caja)	70	35	35	23039	12
		(blister)	70	35	35	23339	15
	Níquel	(caja)	70	35	35	23055	12
		(blister)	70	35	35	23355	15
75P	Níquel	(caja)	75	30	45	23062	12
80P	Latón	(caja)	80	30	50	23040	12
	Níquel	(caja)	80	30	50	23056	12
81P	Latón	(caja)	80	40	40	23041	12
		(blister)	80	40	40	23341	15
	Níquel	(caja)	80	40	40	23057	12
		(blister)	80	40	40	23357	15
60P MC*	Latón	(caja)	60	30	30	23042	12
	Níquel	(caja)	60	30	30	23058	12
70P MC*	Latón	(caja)	70	30	40	23043	12
	Níquel	(caja)	70	30	40	23059	12
71P MC*	Latón	(caja)	70	35	35	23044	12
	Níquel	(caja)	70	35	35	23060	12

Acabado de latón, níquel y níquel satinado
Disponibles en leva de 13,5 y 15 mm

Brass, nickel and satin nickel finish

Available in 13,5 and 15 mm cam

Acabamento em latão, níquel e níquel acetinado
Disponíveis em leva de 13,5 e 15 mm

*MC Estos modelos pueden ser suministrados con la misma llave
These models are available with the same key
Estes modelos podem ser fornecidos com a mesma combinação



anti-taladro
ANTI-DRILLING / ANTI-BERBEQUIM

CILINDRO PRO

llave de seguridad (P)

SECURITY KEY / CHAVE SEGURANÇA (leva de 15 mm)



Por cada entrada en tambor o rotor, primera línea de pitones anti-taladro de acero endurecido (60 HRC)
First line with anti-drilling hardened steel pins (60 HRC)
Primeira linha com anti-berbequim pins em aço endurecido (60 HRC)

Barras de acero endurecido anti-taladro
Anti-drilling hardened steel bars
Anti-berbequim barra em aço endurecido

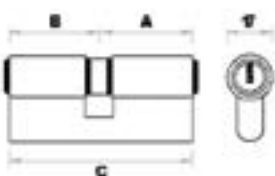
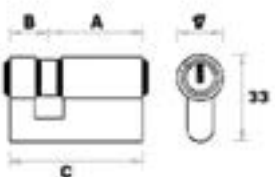

Llave de puntos de 6 claves
6 pins flat key
Chave de pontos de 6 pinos



Tarjeta de seguridad
Security card
Cartão de segurança

		leva 13,5 mm (5 llaves)					
			C	A	B	Ref.	Emb.
60P	Níquel sat.	(caja)	60	30	30	23123	12

		leva 15 mm (5 llaves)					
			C	A	B	Ref.	Emb.
60P	Latón	(caja)	60	30	30	23137	12
65P	Níquel sat.	(caja)	65	55	10	23180	12
85P	Níquel sat.	(caja)	86	55	30	23181	12



1/2 CILINDRO llave dentada (F)

JAGGED KEY / CHAVE DENTADA (leva de 15 mm)

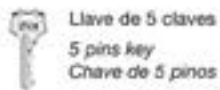

Llave de 5 clavos
5 pins key
Chave de 5 pinos

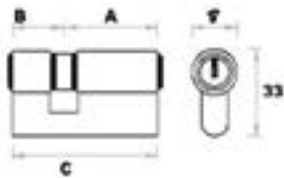

Acabado de latón y níquel satinado
Caja de 12 unidades

Brass and satin nickel finish
12 units box

Acabamento em latão e níquel acetinado
Caixa de 12 unidades

		leva 15 mm (3 llaves)			Ref.	Emb.
		C	A	B		
40F	Latón (caja)	40	30	10	23751	12
	Níquel sat. (caja)	40	30	10	23701	12
45F	Latón (caja)	45	35	10	23752	12
	Níquel sat. (caja)	55	45	10	23754	12
55F	Latón (caja)	55	45	10	23704	12
	Níquel sat. (caja)	70	60	10	23756	12
70F	Latón (caja)	70	60	10	23756	12
80F	Latón (caja)	80	70	10	23757	12
	Níquel sat. (caja)	80	70	10	23707	12

1/2 CILINDRO llave de seguridad (P)

SECURITY KEY / CHAVE SEGURANÇA (leva de 15 mm)

Llave de puntos de 6 clavos
6 pins flat key
Chave de pontos de 6 pinos



		leva 15 mm (3 llaves)			Ref.	Emb.
		C	A	B		
40P	Níquel sat. (caja)	40	30	10	23501	12
45P	Níquel sat. (caja)	45	35	10	23502	12
50P	Níquel sat. (caja)	50	40	10	23503	12
55P	Níquel sat. (caja)	55	45	10	23504	12
60P	Níquel sat. (caja)	60	50	10	23505	12
70P	Níquel sat. (caja)	70	60	10	23506	12
80P	Níquel sat. (caja)	80	70	10	23507	12

Acabado en níquel satinado
Caja de 12 unidades

Cabeza de la llave en PVC

Satin nickel finish

12 units box

PVC head key

Acabamento em níquel acetinado

Caixa de 12 unidades

Cabeza de la llave en PVC

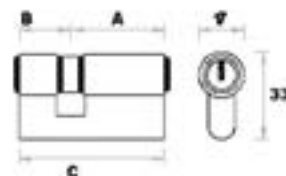

CILINDRO C/POMO llave de seguridad (P)

KNOB CILINDER. SECURITY KEY
(leva de 15 mm) CANHAO E MANIPULO CHAVE SEGURANÇA

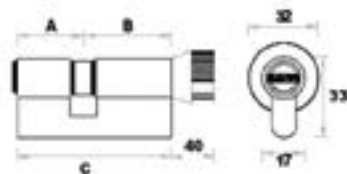

Llave de puntos de 6 clavos
6 pins flat key
Chave de pontos de 6 pinos

		leva 15 mm (3 llaves)			Ref.	Emb.
		C	A	B		
60P	Níquel sat. (caja)	60	30	30	23592	12
65P	Níquel sat. (caja)	65	30	35	23593	12
70P	Níquel sat. (caja)	70	30	40	23591	12
	Latón (caja)	70	40	30	23625	12
75P	Níquel sat. (caja)	70	40	30	23603	12
	Níquel sat. (caja)	75	30	45	23594	12
75P	Níquel sat. (caja)	75	35	40	23600	12
	Níquel sat. (caja)	75	45	30	23608	12
80P	Latón (caja)	80	30	50	23629	12
	Níquel sat. (caja)	80	30	50	23595	12
80P	Níquel sat. (caja)	80	35	45	23601	12
	Níquel sat. (caja)	80	45	35	23609	12
80P	Latón (caja)	80	50	30	23626	12
	Níquel sat. (caja)	80	50	30	23613	12
85P	Níquel sat. (caja)	85	30	55	23596	12
	Níquel sat. (caja)	85	35	50	23602	12
85P	Níquel sat. (caja)	85	40	45	23605	12
	Níquel sat. (caja)	90	30	60	23597	12
90P	Níquel sat. (caja)	90	40	50	23606	12
	Níquel sat. (caja)	90	45	45	23610	12
90P	Níquel sat. (caja)	90	50	40	23614	12
	Latón (caja)	90	60	30	23627	12
95P	Níquel sat. (caja)	95	45	50	23611	12
100P	Níquel sat. (caja)	100	30	70	23598	12
	Níquel sat. (caja)	100	40	60	23607	12
100P	Níquel sat. (caja)	100	45	55	23612	12
	Níquel sat. (caja)	100	50	50	23615	12
100P	Níquel sat. (caja)	100	60	40	23617	12
	Latón (caja)	100	70	30	23628	12
110P	Níquel sat. (caja)	110	50	60	23616	12

Acabado de latón y níquel satinado

Caja de 12 unidades

Cabeza de la llave en PVC

Brass and satin nickel finish

12 units box

PVC head key

Acabamento em latão e níquel acetinado

Caixa de 12 unidades

Cabeza de la llave en PVC

CILINDRO OVALADO

OVAL CYLINDER / CANHAO OVAL (leva de 11 mm)

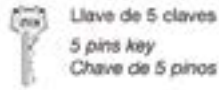
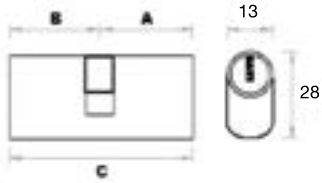

leva 11 mm (3 llaves)							
		C	A	B	Ref.	Emb.	
Oval	Latón	(caja)	56	28	28	23850	12

Acabado de latón
Caja de 12 unidades
Brass finish
12 units box
Acabamento em latão
Caixa de 12 unidades

CILINDRO C/PERNO PARA POMO

llave de seguridad (P)

CYLINDER WITH PIN FOR KNOB. SECURITY KEY

CANHAO COM PARAFUSO PARA POMO.

CHAVE SEGURANÇA

(leva de 15 mm)

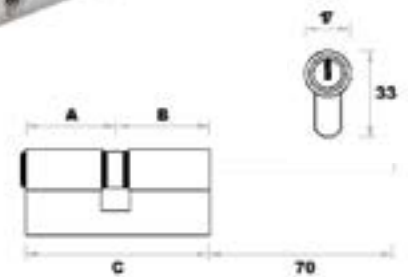

leva 15 mm (3 llaves)							
			C	A	B	Ref.	Emb.
60P	Níquel sat.	(caja)	60	30	30	23651	12
65P	Níquel sat.	(caja)	65	35	30	23652	12
70P	Latón	(caja)	70	40	30	23675	12
	Níquel sat.	(caja)	70	40	30	23653	12
75P	Níquel sat.	(caja)	75	45	30	23654	12
80P	Latón	(caja)	80	50	30	23676	12
	Níquel sat.	(caja)	80	50	30	23655	12
90P	Latón	(caja)	90	60	30	23677	12
	Níquel sat.	(caja)	90	60	30	23656	12
100P	Latón	(caja)	100	70	30	23678	12

Acabado de latón y níquel satinado
Caja de 12 unidades
Cabeza de llave de PVC

Brass and satin nickel finish
12 units box
PVC head key

Acabamento em latão e níquel acetinado
Caixa de 12 unidades
Cabeza de la clave em PVC

Llave de puntos de 6 claves
6 pins flat key
Chave de pontos de 6 pinos

CILINDRO PIÑÓN

PINION CYLINDER / CANHAO COM SISTEMA DE CARRETE



10 dientes

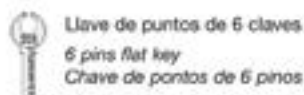
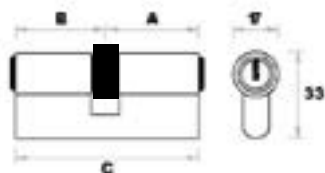

503 - 504 (5 llaves)							
			C	A	B	Ref.	Emb.
Níquel	(caja)		60	30	30	07014	4
Níquel	(caja)		70	30	40	07015	4

CILINDRO CDF

PARA IGUALAMIENTO CON SISTEMAS RP Y LP

leva 15 mm (5 llaves)							
			C	A	B	Ref.	Emb.
CDF P	Latón	(caja)	70	35	35	07050	1
CDF P	Latón	(caja)	80	40	40	07051	1
CDF P	Níquel	(caja)	70	35	35	07060	1
CDF P	Níquel	(caja)	80	40	40	07061	1



CILINDRO RK

PERFIL EUROPEO

RED KEY ANTI-BUMPING

UNE EN 1303
MÁXIMA SEGURIDAD
CERTIFICADA

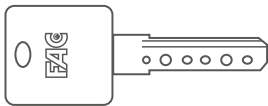
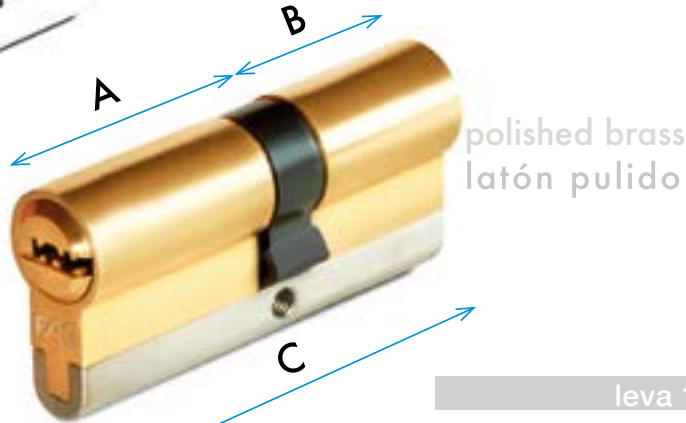

Llave de puntos reversible de 6 claves

6 pins dimple reversible key

5 unidades por cilindro

5 pcs per cylinder

Dispone de 12 pitos Anti-bumping cargados a muelle en situación de espera que actúan de rebloqueo ante un intento de manipulación por efecto bumping

Anti-bumping blockage system provided by 12 spring-loaded pins acts in case of lock bumping attempt

Acabado: níquel satinado y latón pulido

Finish: satin nickel and polished brass

LLAVE RK

Ref.

en Bruto 690000084000

confeccionada 690010176000

CILINDRO RK

Ref.

misma clave 99010

leva 15 mm (5 llaves)

			C	A	B	Ref.	Emb.
RK	Latón	(caja)	60	30	30	23237	12
RK	Latón	(caja)	70	30	40	23238	12
RK	Latón	(caja)	70	35	35	23239	12
RK	Latón	(caja)	80	30	50	23240	12
RK	Latón	(caja)	80	40	40	23241	12

leva 15 mm (5 llaves)

			C	A	B	Ref.	Emb.
RK	Níquel sat.	(caja)	60	30	30	23253	12
RK	Níquel sat.	(caja)	70	30	40	23254	12
RK	Níquel sat.	(caja)	70	35	35	23255	12
RK	Níquel sat.	(caja)	80	30	50	23256	12
RK	Níquel sat.	(caja)	80	40	40	23257	12

Anti-Drill

ANTI TALADRO

barras/primeros pitones en:
Acero reforzado/inoxidable

Anti-Extraction
ANTIEXTRACCIÓN

Resistencia 15Kn

pitones diábolo alternos

ANTI GANZÚA

Anti-Pick

Acero reforzado

placa ANTI ROTURA

Anti-Snap bar

Acero inoxidable
ANTI BUMPING
12 pitones diábolo



FAC SEGURIDAD, S.A. lanza un nuevo cilindro de alta seguridad que actualmente demanda el mercado. Nuevas y mejoradas prestaciones gracias a la combinación de un nuevo diseño y materiales ultrarresistentes. Y manteniendo las medidas y forma del Perfil Europeo.





cierrapuertas

DOOR CLOSERS · FECHA PORTAS

FAC



CIERRAPUERTAS



CR 1003		
	Ref.	Embalaje
blanco	32001	1
negro	32002	1
plata	32003	1
oro	32004	1

SR 1003		
	Ref.	Embalaje
blanco	32101	1
negro	32102	1
plata	32103	1
oro	32104	1

instalación paralela		
	Ref.	Embalaje
blanco	32901	1
negro	32902	1
plata	32903	1
oro	32904	1

Triangular design in compact size
 Universal application for standard or parallel arm installation (optional accessory)
 Cast aluminium alloy case
 Size EN3 for a maximum door width of 950 mm
 Maximum door weight: 65 Kg
 Speed easy to adjust. Two separate closing and latching speed valves adjust for 180°-15°-0°
 Hold open system adjustable between 120° and 180°
 Easy and fast installation with mounting paper template
 Installation options:
 • Standard: Door opens inwards.
 The closer is installed on the leaf, on the hinged side and the arm is fixed on the door frame.
 • Parallel arm: Door opens outwards.
 When it is not possible to install the body on the door frame, the door closer is mounted on the leaf, on the side opposite to the hinges and the arm is fixed on the door frame with a parallel arm installation bracket (available under request)

Diseño triangular en tamaño compacto
 Aplicación universal para instalación estandar o en brazo paralelo (accesorio opcional)
 Cuerpo fabricado en aleación de aluminio fundido
 Fuerza de cierre EN3 para ancho máximo de puerta: 950 mm
 Peso de puerta máximo 65 Kg
 Velocidad fácil de ajustar
 Dos válvulas diferentes de cierre y golpe final para 180°-15°-0°
 Sistema de retención regulable entre 120° y 180°
 Fácil y rápida instalación con plantilla para montaje
 Posibilidades de instalación:
 • Normal: Apertura hacia el interior.
 El cierrapuertas se instala en la puerta sobre la hoja en el lado de las bisagras y el brazo se fija en el marco
 • Brazo paralelo: Apertura hacia el exterior cuando no es posible montar el cuerpo sobre el marco.
 El cierrapuertas se instala en la puerta sobre la hoja en el lado opuesto al de las bisagras y el brazo se fija al marco por medio de un soporte específico de instalación (disponible bajo pedido)

Desenho triangular em tamanho compacto
 Aplicação universal para instalação standard ou em braço paralelo (accesório opcional)
 Corpo fabricado em liga de alumínio fundido
 Força de fecho em 3 para largura máxima de porta: 950 mm
 Peso de porta máximo: 65 Kg
 Velocidade fácil de ajustar. Duas válvulas diferentes de fecho e golpe final para 180°-15°-0°
 Sistema de retenção regulável entre 120° e 180°
 Fáci e rápida instalação com molde para montagem
 Possibilidades de instalação:
 • Normal: abertura para o interior o fachaportas instala-se na porta sobre a lâmina no lado das dobradiças e o braço fixa-se na guarnição da porta
 • Braço paralelo: abertura para o exterior quando não é possível montar o corpo sobre a guarnição da porta o fachaportas instala-se na porta sobre lâmina no lado oposto ao das dobradiças e o barco fixa-se à guarnição através de um suporte específico de instalação (disponível a pedido)





candados

PADLOCKS · CADEADOS

FAC

ARCO NORMAL

NORMAL SHACKLE / ARCO NORMAL



	15	20	25	30	40	50	60	70
A	17	20	25	30	40	50	60	70
B	17	20	25	27	32	42	50	58
C	12	12	15	18	24	27	35	44
D	3	3	5	5	6	8	10	12
E	9	11	12	16	22	27	33	38
F	9	11	12	13	15	17	21	24



Llave de 5 clavés
5 pins key
Chave de 5 pinos



Llave de 4 clavés
4 pins key
Chave de 4 pinos

Estos modelos pueden ser suministrados con la misma clave
Acabado en latón
Doble cierre (excepto mod. 15, 20 y 25 mm)
Arco endurecido (excepto mod. 15, 20 y 25 mm)
Cilindro de latón con 3 llaves
Disponibles en caja y blíster

Available with the same key
Brass plated finish
Double locking system (except mod. 15, 20 and 25 mm)
Hardened shackle (except mod. 15, 20 and 25 mm)
Brass cylinder with 3 keys
Available in box and blister

Estos modelos estão disponíveis com a mesma combinação
Acabamento em latão
Doble cierre (excepto mod. 15, 20 y 25 mm)
Arco endurecido (excepto mod. 15, 20 y 25 mm)
Cilindro de latão com 3 chaves
Disponível em caixa e blister

arco normal				
	nº clavés		Ref.	Emb.
15 mm	4	(caja)	20001	12
	4	(blister)	20301	6
MC*	4	(caja)	20013	12
	4	(blister)	20302	6
20 mm	4	(caja)	20002	12
	4	(blister)	20302	6
MC*	4	(caja)	20014	12
	4	(blister)	20303	6
25 mm	4	(caja)	20003	12
	4	(blister)	20303	6
MC*	4	(caja)	20015	12
	4	(caja)	20004	12
30 mm	4	(blister)	20304	6
	4	(caja)	20016	12
40 mm	5	(caja)	20005	6
	5	(blister)	20305	6
MC*	5	(caja)	20017	6
	5	(caja)	20006	6
50 mm	5	(blister)	20306	6
	5	(caja)	20018	6
60 mm	5	(caja)	20007	6
	5	(blister)	20307	6
MC*	5	(caja)	20019	6
	5	(caja)	20020	6
70 mm	5	(blister)	20300	6
	5	(caja)		

MC* Misma clave. Same key. Mesma combinação

ARCO LARGO

LONG SHACKLE / ARCO LONGO



Estos modelos pueden ser suministrados con la misma clave
 Acabado en latón
 Doble cierre (excepto mod. 15, 20 y 25 mm)
 Arco endurecido (excepto mod. 15, 20 y 25 mm)
 Cilindro de latón con 3 llaves
 Disponibles en caja y blíster

Available with the same key
 Brass plated finish
 Double locking system (except mod. 15, 20 and 25 mm)
 Hardened shackle (except mod. 15, 20 and 25 mm)
 Brass cylinder with 3 keys

Available in box and blister
 Estes modelos estão disponíveis com a mesma combinação
 Acabamento em latão
 Doble cierre (excepto mod. 15, 20 e 25 mm)
 Arco endurecido (excepto mod. 15, 20 e 25 mm)
 Cilindro de latão com 3 chaves
 Disponível em caixa e blister

arco largo				
	nº claves		Ref.	Emb.
20 mm	4	(caja)	20008	12
	4	(blister)	20308	6
MC*	4	(caja)	20037	12
	4	(caja)	20009	12
25 mm	4	(caja)	20009	12
	4	(blister)	20309	6
MC*	4	(caja)	20038	12
	4	(caja)	20010	12
30 mm	4	(caja)	20010	12
	4	(blister)	20310	6
MC*	4	(caja)	20022	12
	4	(caja)	20011	6
40 mm	5	(caja)	20011	6
	5	(blister)	20311	6
MC*	5	(caja)	20023	6
	5	(caja)	20012	6
50 mm	5	(caja)	20012	6
	5	(blister)	20312	6
MC*	5	(caja)	20024	6

MC* Misma clave. Same key. Mesma combinação



Llave de 5 claves
 5 pins key
 Chave de 5 pinos



Llave de 4 clavet
 4 pins key
 Chave de 4 pinos



	20	25	30	40	50
A	20	25	30	40	50
B	20	25	27	32	42
C	27	27	34	47	55
D	3	5	5	6	8
E	11	12	16	22	27
F	11	12	13	15	17

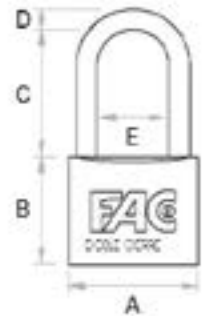

INOX

INOX / INOX



Cuerpo y arco de acero inoxidable
 Componentes internos de acero
 Sistema de cierre mediante 2 cónicas
 Apertura y cierre mediante llave
 Disponibles en caja y blíster
 Suministrado con 3 llaves

Lock body and shackle made of high quality stainless steel
 Inside parts made of rustproof materials
 Double ball locking system
 Lock and unlock with a key
 Available in box and blister
 Supplied with 3 keys

Corpo e arco de aço inoxidável
 Componentes internos em aço
 Sistema de trancamento através de 2 cónicas
 Trancamento através de chave
 Disponível em caixa e blister
 Fornecidos com 3 chaves

inox				
	nº claves		Ref.	Emb.
40 mm	5	(blister)	20313	12
50 mm	5	(caja)	20031	12
	5	(blister)	20314	12
70 mm	5	(blister)	20324	6



	40	50	60	70
A	40	50	60	70
B	52	60	70	70
C	14	20	25	30
D	15	22	23	25
E	7	9,5	10	12

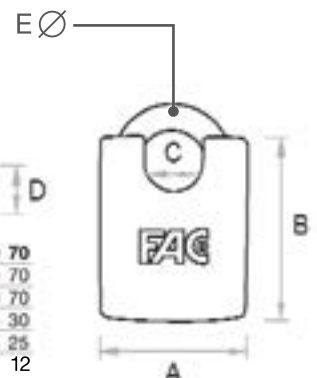

Llave de 5 claves
 5 pins key
 Chave de 5 pinos

ARCO NORMAL PRO

NORMAL SHACKLE / ARCO NORMAL



arco normal pro				
	nº claves		Ref.	Emb.
15 mm	3	(caja)	20500	1
20 mm	3	(caja)	20501	1
25 mm	3	(caja)	20502	1
30 mm	4	(caja)	20503	1
40 mm	4	(caja)	20504	1
50 mm	5	(caja)	20505	1
60 mm	5	(caja)	20506	1

CARACTERÍSTICAS DEL CANDADO PRO

Solid brass padlock
 Cylinder with jagged key. **High precision** mechanization that favours a perfect timing among pins and key.
 Inside parts made of **rutsproof** materials.
 High quality shackle, heat treatment (**double nitrogenation of carbon**) from 20 mm.
 Shackle highly resistant to shear and saw cutting.
 Chromed shackle treated chemically with **3 anti-rust layers**.
 Shackle with double-lock mechanism from 30 mm.

Candado de latón macizo.
 Cilindro de llave dentada de **alta precisión** de mecanización, que favorece a la perfecta sincronización entre llave y pitones.
 Componentes internos **inoxidables**.
 Arco de acero de alta calidad, tratado térmicamente (**doble proceso de carbonitruración**) a partir de 20 mm.
 Arco con mayor resistencia al corte por cizalla y sierra.
 Arco cromado, tratado químicamente con **3 capas anticorrosión**. Mecanismo de doble bloqueo del arco a partir de 30 mm.

Cadeado de latão maciço
 Cilindro de chave dentada de **alta precisão** de mecanização, que favorece a perfeita sincronização entre chave e pitões.
 Componentes internos **inoxidáveis**.
 Arco de aço de alta qualidade, tratado térmicamente (**duplo processo de carbonitruração**) a partir de 20mm.
 Arco com maior resistência ao corte por cisalha e serra.
 Arco cromado, tratado químicamente com **3 camadas anti-corrosão**.
 Mecanismo de duplo bloqueio do arco a partir de 30mm.

ARCO LARGO PRO

LONG SHACKLE / ARCO LONGO

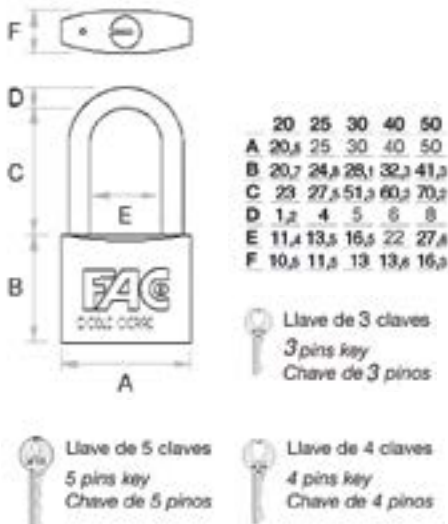

arco largo pro				
	nº claves		Ref.	Emb.
20 mm	3	(caja)	20508	1
25 mm	3	(caja)	20509	1
30 mm	4	(caja)	20510	1
40 mm	4	(caja)	20511	1
50 mm	5	(caja)	20512	1

MARINO

MARINE NORMAL SHACKLE / MARINO ARCO NORMAL

Estos modelos pueden ser suministrados con la misma clave
Acabado en latón cromado
Arco y componentes interiores de acero inoxidable
Cilindro cromado de llave dentada
Disponibles en caja y blíster
Suministrado con 3 llaves

Available with the same key
Chrome plated and brass body
Shackle and inside parts made of stainless steel
Chrome jagged key cylinder
Available in box and blister
Supplied with 3 keys

Estos modelos estão disponíveis com a mesma combinação
Corpo de latão cromado
Arco e componentes internos em aço inoxidável
Cilindro cromado de chave dentada
Disponível em caixa e blister
Fornecidos com 3 chaves



marino				
	n° claves		Ref.	Emb.
30 MC*	4	(caja)	20401	12
40 mm	5	(caja)	20318	12
	5	(blister)	20422	6
MC*	5	(caja)	20402	12
50 mm	5	(caja)	20317	6
	5	(blister)	20423	6
MC*	5	(caja)	20403	6
60 mm	5	(caja)	20322	6
	5	(blister)	20424	6

MC* Misma clave. Same key. Mesma combinação

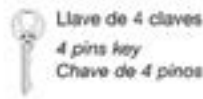
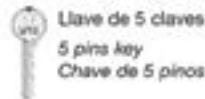

	30	40	50	60
A	30	40	50	60
B	28	33	39	50
C	17	24	30	35
D	5	5	8	10
E	16	23	28	33
F	13	13	17	21

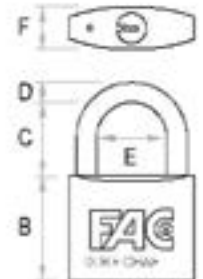

MARINO ARCO LARGO

MARINE LONG SHACKLE / MARINO ARCO LONGO

Estos modelos pueden ser suministrados con la misma clave
Acabado en latón cromado
Arco y componentes interiores en acero inoxidable
Cilindro cromado de llave dentada
Disponibles en caja y blister
Suministrado con 3 llaves

Available with the same key
Chrome plated and brass body
Shackle and inside parts made of stainless steel
Chrome jagged key cylinder
Available in box and blister
Supplied with 3 keys

Estos modelos estão disponíveis com a mesma combinação
Corpo de latão cromado
Arco e componentes internos em aço inoxidável
Cilindro cromado de chave dentada
Disponível em caixa e blister
Fornecidos com 3 chaves



marino arco largo				
	n° claves		Ref.	Emb.
30 MC*	4	(caja)	20411	12
40 mm	5	(caja)	20321	6
MC*	5	(caja)	20412	6
50 mm	5	(caja)	20320	6
	5	(blister)	20433	6
MC*	5	(caja)	20413	6

MC* Misma clave. Same key. Mesma combinação

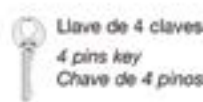
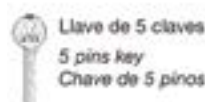

	30	40	50
A	30	40	50
B	28	33	39
C	32	42	49
D	5	5	8
E	16	23	28
F	13	13	17

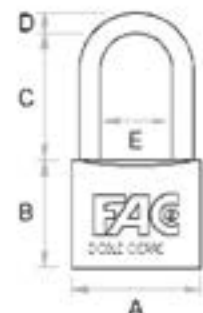

RECTANGULAR

RECTANGULAR / RETANGULAR



	60	70	90
A	60	70	90
B	45	55	65
C	18	22	36
D	17	20	20
E	14	16	19
Ø	10	12	12

Acabado en latón
Arco endurecido
Cilindro de latón con 2 llaves

Brass plated finish
Hardened shackle
Brass cylinder with 2 keys

Acabamento em latão
Arco endurecido
Cilindro de latão com 2 chaves

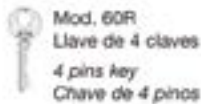
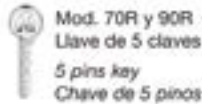

rectangular		
	Ref.	Emb.
60 R (caja)	21001	6
(blister)	21301	6
MC* (caja)	21201	6
70 R (caja)	21002	6
(blister)	21302	6
MC* (caja)	21202	6
90 R (caja)	21003	6
(blister)	21303	6
MC* (caja)	21203	6

MC* Misma clave. Same key. Mesma combinação



BLINDADO

ARMOURED / BLINDADO

81

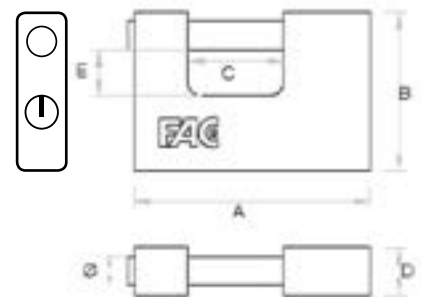

	60	80	90
A	62	81	91
B	55	68	75
C	22	30	36
D	24	29	29
E	12	14	18
Ø	10	11	12

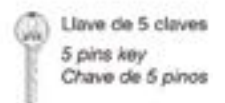

Cuerpo de latón macizo blindado por medio de carcasa de acero endurecido y cromado
Bulón de cierre en acero endurecido cromado
Mecanismo de cierre por bola de acero
Disco de protección del cilindro con sistema antitaladro y extracción
Solid brass armoured body with a hardened steel and chrome plated case
Hardened steel and chrome plated shackle
Steel ball bearing locking system
Anti-drill cylinder resistance

Corpo de latão maciço blindado com caixa de arco endurecido e cromado
Trinco de fecho em aço endurecido e cromado
Mecanismo de fecho de porosfera de aço
Disco de proteção do cilindro com sistema anti-perfuração

blindado		
	Ref.	Emb.
60 R (caja)	21401	1
80 R (caja)	21402	1
90 R (caja)	21403	1

CIRCULAR

ROUND / CIRCULAR



circular				
	nº claves		Ref.	Emb.
70 C	4	(caja)	20028	12
	4	(blister)	20029	12

Carcasa de acero inoxidable
Arco endurecido y cromado
Apertura y cierre mediante llave
Suministrado con 2 llaves

Stainless steel case
Hardened and chrome plated shackle
Lock and unlock with a key
Supplied with 2 keys

Estrutura de aço inoxidável
Arco endurecido e cromado
Trancamento através de chave
Fornecidos com 2 chaves

Llave de 4 claves
4 pins key
Chave de 4 pinos

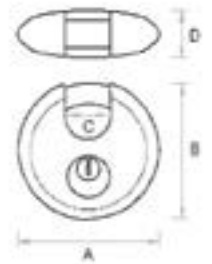

A 70
B 70
C 20
D 25

COMBINACIÓN

COMBINATION / COMBINAÇÃO



Candados de combinación con
4 diales
Cuerpo de latón
Arco de acero

Combination padlock with
4 wheels
Brass body
Steel shackle

Cadeado de combinação de
4 rodas
Cadeado de latão
Arco aço

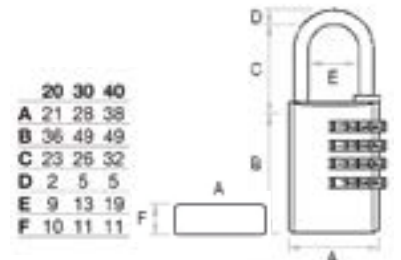

	20	30	40
A	21	28	38
B	36	49	49
C	23	26	32
D	2	5	5
E	9	13	19
F	10	11	11

combinación				
			Ref.	Emb.
20 mm				
30 mm	(blister)		20033	6
40 mm	(blister)		20034	6



Acabado cromado
Cuerpo de pletina calibrada de 40x10 mm
Cilindro de latón con 3 llaves
Disponibile en unidades y parejas con misma llave

Chrome plated finish 40x10 mm flatbar body
Brass cylinder with 3 keys
Available in units and sets with same key

Acabamento cromado
Corpo de aço de 40x10 mm
Cilindro de latão com 3 chaves
Disponível em unidades e pares mesma chave

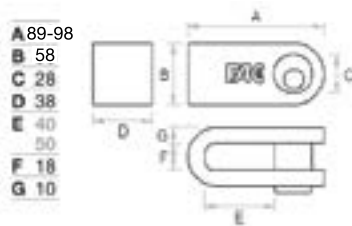

A 89-98
B 58
C 28
D 38
E 40
50
F 18
G 10

Llave de 6 claves
6 pins key
Chave de 6 pinos



506				
	n° claves		Ref.	Emb.
40	6	(unidad)	02301	1
	6	(juego 2)	02302	1
50	6	(unidad)	02303	1
	6	(juego 2)	02304	1

PORTA CANDADOS HASP & STAPLE / PORTA CADEADOS



Placa de acero de 1,5 mm
Cerradero de acero endurecido
Perno de acero de 4 mm
Placa niquelada
Disponibile en blister

Steel sheet of 1,5 mm
Steel hardened striking plate 4 mm steel bolt
Nickel plated plate
Available in blister

Placa em aço de 1,5 mm
Trancador em aço
Trinco de aço de 4 mm
Acabamento em niquelado
Disponível em blister

75 115
A 27 45
B 71 112
C 29 47
D 28 23

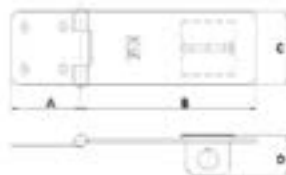

porta candados				
			Ref.	Emb.
PC 75	(blister)		20340	6
PC 115	(blister)		20341	6

ANTIRROBO 82

STEERING WHEEL ANTI-THEFT LOCK BAR / BARRA ANTI-ROUBO

Acabado niquelado
Arco de cremallera en acero calibrado tratado de Ø 10 mm
Gancho en acero calibrado tratado
Arco interior orientable
Cilindro de latón con 3 llaves
2 horquillas distintas para pedal ancho y estrecho

Nickel plated finish
Zip shackle of Ø 10 mm treated steel
Treated steel hook
Rotary lower shackle
Brass cylinder with 3 keys
2 different sizes

Acabamento niquelado
Arco de cremalheira em aço de Ø 10 mm
Gancho de aço
Arco interior orientável
Cilindro de latão com 3 chaves
2 barras distintas para trancamento largo e estreito

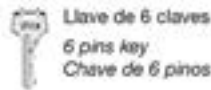
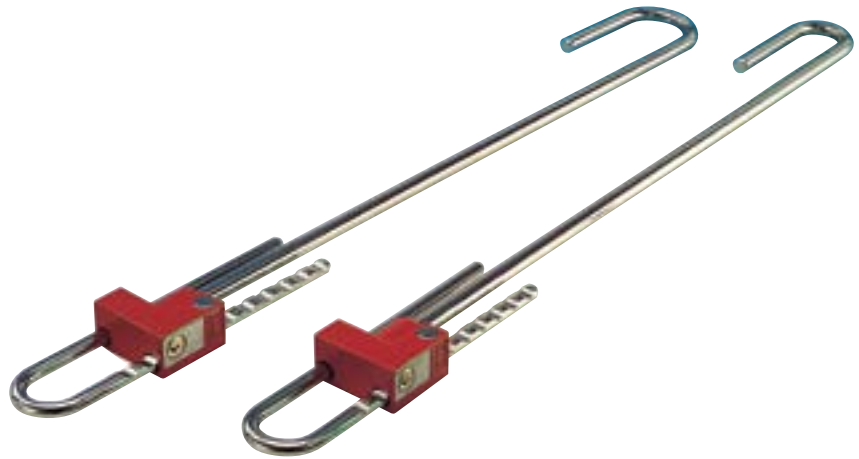

A 730-590
B 30
C 28
D 43

antirrobo 82		
	Ref.	Emb.
normal	06501	6
ancho	06502	6

ANTIRROBO CAR

STEERING WHEEL ANTI-THEFT LOCK BAR / BARRA ANTI-ROUBO

Cuerpo acabado pintado / cromado
Arco de acero calibrado de Ø 12 mm
Cilindro de latón con 2 llaves
Doble cierre

Body with painted / chromed finish
Ø 12 mm calibrated steel bar shackle
Brass cylinder with 2 keys
Double locking system

Corpo com acabamento pintado/cromado
Arco de aço calibrado de Ø 12 mm
Cilindro de latão com 2 chaves
Fecho duplo

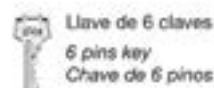

A 500
B 43

antirrobo car		
	Ref.	Emb.
car	06507	8

530/70 • 530/150

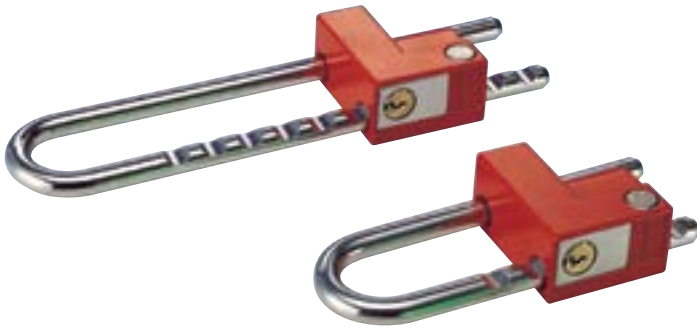

Acabado niquelado
Arco de cremallera extensible en acero calibrado tratado de Ø 10 mm
Cilindro de latón con 2 llaves

Nickel plated finish
Extending zip shackle of Ø 10 mm treated steel
Brass cylinder with 2 keys

Acabamento niquelado
Arco de cremalheira extensível em aço de Ø 10 mm
Cilindro de latão com 2 chaves

530			
		Ref.	Emb.
70	(blister)	02311	6
150	(blister)	02312	6

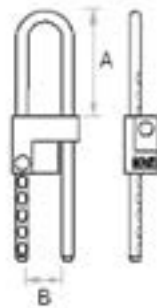

Llave de 6 clavos
6 pins key
Chave de 6 pinos

A 47-123 (70)
47-107 (150)
B 30

75/90 • 75/140

75		
	Ref.	Emb.
90	02315	6
140	02316	6



Llave de 6 clavos
6 pins key
Chave de 6 pinos

Corpo com acabamento cromado
Arco de aço calibrado de Ø 12 mm
Cilindro de latão com 2 chaves
Fecho duplo

A 75
B 36
C 93-140
D 12
E 43

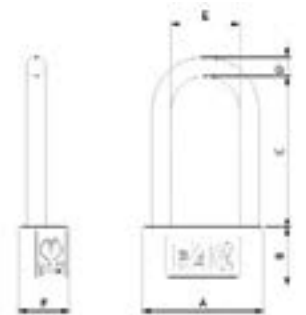

Cuerpo acabado cromado
Arco de acero calibrado de Ø 12 mm
Cilindro de latón con 2 llaves
Doble cierre

Body with chrome plated finish
Ø 12 mm calibrated steel bar shackle
Brass cylinder with 2 keys
Double locking system

ANTIRROBO MOTO

MOTORCYCLE ANTI-THEFT / ANTI-ROUBO MOTO



Acabado pintado
Cuerpo macizo de inyección metálica
Mecanismo de cierre automático y llave tubular
Bulón de cierre en acero tratado
Apto para cualquier moto con disco ventilado

Painted finish
Solid body of metallic injection
Automatic locking mechanism and tubular key
Treated steel bolt
Suitable for any motorcycle with air cooled brake disk

Acabamento pintado
Corpo maciço de injeção metálica
Mecanismo de trinco automático e chave tubular
Lingueta de trinco em aço tratado
Apto para qualquer mota com disco ventilado

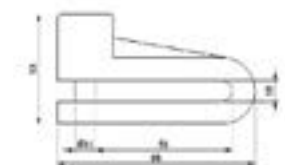

moto			
		Ref.	Emb.
30	(blister)	06001	1
60	(blister)	06003	1





cajas fuertes de empotrar

WALL SAFES · COFRES DE EMBUTIR

FAC

ÍNDICE ICONOGRÁFICO



Apertura con llave
Key opening
Abertura com chave



Apertura electrónica
Electronic opening
Abertura eletrónica



Apertura con mando
Telecomand opening
Abertura com comando



Secreto
Mechanical combination
Combinação numérica



Pomo
Knob
Manípulo



Volante
Wheel
Volante



Maneta
Handle
Maçaneta



Cierre con bulones
Locking bolts
Fecho com linguetas



Cierre integral
Locking no bolts
Fecho integral



Receptora
Slot
Ranhura



Puerta de chapa de acero
Door thickness
Porta em chapa de aço



Cuerpo de chapa de acero
Body thickness
Corpo em chapa de aço



Cerco de chapa de acero
Frame thickness
Frontal em chapa de aço

S.O.S.

Apertura de emergencia
Emergency opening
Abertura de emergencia

Algunos modelos con apertura electrónica están dotados con llave de emergencia que permite abrir la caja en los supuestos de agotamiento o ausencia de pilas y también en caso de fallo del sistema electrónico.

Some models with electronic opening system have emergency key in case of batteries run down.

Alguns modelos com abertura electrónica dispõem de chave de emergência para abrir o cofre forte em caso de esgotamento das pilhas.

SISTEMAS MECÁNICOS

MECHANIC SYSTEMS / SISTEMAS MECÁNICOS



Cerradura de gorgas con llave de doble paletón con 8 claves

Levers key lock

Fechadura de gorges com chave de palhetão de 8 pinos

Serie: 100 LL, 100 SLL, 100 ILL
Modelo: 105 LLB, 105 SLL
Librería Buro 1812, Época 1931



Llave de doble paletón y combinación mecánica (secreto)



Levers key & mechanical combination

Chave de duplo palhetão e manípulo de combinação numérica

Serie: 100 M, 100 MS
Serie: 105 MB, 105 MSB
Modelo: 9081



Llave de doble paletón, combinación numérica (secreto) y volante



Levers key, mechanical combination & wheel



Chave de duplo palhetão e manípulo de combinação numérica e volante

Serie: 2083 B/C
Serie: 3083 B/C



Cilindro de latón protegido

Protected brass cylinder

Cilindro de latão protegido

Modelo: 901 J, 100 mini LL,
6570 C/T



Cerradura de gorgas clase A o B Normativa VDS/EN 1303

Levers lock class A or B VDS/EN 1303 certification

Fechadura de gorges clase A ou B Normativa VDS/EN 1303

Serie: SAFARI, ÉLITE, ÉLITE 2LL, M y E, ALFA, GREDOS, TARGET, ARMARIO AR y PETRA



Apertura con llave
Key opening

SISTEMAS ELECTRÓNICOS

ELECTRONIC SYSTEMS / SISTEMAS ELETRÔNICOS



Llave de doble paletón combinación electrónica y sistema de emergencia



Levers key, electronic combination and emergency system

S.O.S.

Chave de duplo palhetão, combinação eletrónica e sistema de emergência

Serie: 100 E, 100 ES
Serie: 9081 EAS/EASD
Serie: Plus



Pomo, combinación electrónica y sistema de emergencia



Knob, electronic combination and emergency system

Manípulo, combinação eletrónica e sistema de emergência

S.O.S.

Serie: 100 ESP
Serie: 100 ESPH
Serie: 100 Rasha



Electrónica motorizada y sistema de emergencia

Electronic motorised system & emergency system

S.O.S.

Abertura electrónica motorizada e sistema de emergência

Serie: 100 IE, 100 IES,
100 IES evolución
Serie: 400
Modelo: 100 EPC



Apertura eletrónica con mando a distancia por infrarrojos y sistema de emergencia

Electronic opening system con remote control and emergency system

S.O.S.

Abertura electrónica com comando à distância e sistema de emergência

Modelo: Época 1931

100 LL

EMPOTRAR

WALL SAFES / COFRES DE EMBUTIR



102 LL



100 LL mini

Mecánicas sólo llave
Key only
Com chave

Apertura con llave
Key opening

 100 LL mini

 101 LL, 102 LL,
103 LL, 104 LL

 Cierre con bulones
Locking bolts

100 LL mini 2 bulones / Bolts
101 LL 2 bulones / Bolts
102 LL 2 bulones / Bolts
103 LL 4 bulones / Bolts
104 LL 4 bulones / Bolts

 PUERTA Chapa de acero
Door Thickness

100 LL mini 5 mm
101 LL 6 mm
102 LL 6 mm
103 LL 6 mm
104 LL 6 mm

 CUERPO 2 mm
Chapa de acero
Body Thickness

 CERCO 4 mm
Chapa de acero
Frame Thickness



102 ILL brico

Mecánicas sólo llave
Key only
Com chave

 PUERTA 6 mm
Chapa de acero
Door Thickness

 CUERPO 2 mm
Chapa de acero
Body Thickness

 CERCO 4 mm
Chapa de acero
Frame Thickness

 Apertura con llave
Key opening

 integral

Sistema de cierre integral
Locking system no bolts



102 ILL brico						
	alto	ancho	fondo	kg	litros	Ref.
Ext.	290	370	220	13,6	11	15002
Int.	210	330	160			

100 LL mini						
	alto	ancho	fondo	kg	litros	Ref.
Ext.	170	240	125	4	1,6	05436
Int.	110	190	80			

101 LL						
	alto	ancho	fondo	kg	litros	Ref.
Ext.	240	350	220	11	8	05449
Int.	160	310	165			

102 LL						
	alto	ancho	fondo	kg	litros	Ref.
Ext.	290	370	220	13	11	05450
Int.	210	335	165			

103 LL						
	alto	ancho	fondo	kg	litros	Ref.
Ext.	380	485	220	20	22	05451
Int.	300	450	165			

104 LL						
	alto	ancho	fondo	kg	litros	Ref.
Ext.	485	380	310	22	35	05452
Int.	450	345	255			

100 ILL

EMPOTRAR

WALL SAFES / COFRES DE EMBUTIR

Puerta corredera integral sin bulones. Sistema patentado
Sliding door without bolts. Patented locking system
Porta deslizante integral sem trincos. Sistema patentado



102 M

Mecánicas

Key & Mechanical combination

Chave e combinação



Apertura con llave
Key opening



Secreto
Mechanical combination



Cierre con bulones
Locking bolts

101 M 2 bulones / Bolts
102 M 2 bulones / Bolts
103 M 4 bulones / Bolts
104 M 4 bulones / Bolts



101 M						
	alto	ancho	fondo	kg	litros	Ref.
Ext.	240	350	220	11	8	05445
Int.	160	310	165			

102 M						
	alto	ancho	fondo	kg	litros	Ref.
Ext.	290	370	220	14	11	05446
Int.	210	335	165			

103 M						
	alto	ancho	fondo	kg	litros	Ref.
Ext.	380	485	220	20,5	22	05447
Int.	300	450	165			

104 M						
	alto	ancho	fondo	kg	litros	Ref.
Ext.	485	380	310	22,5	35	05448
Int.	405	345	255			



103 M plus

100 M plus

EMPOTRAR

WALL SAFES / COFRES DE EMBUTIR

Puerta y frontal de 10 mm de espesor, enrasados y cortados por láser

Bulones superiores e inferiores

Door and frame of 10 mm thickness laser cutting
Up and down bolts

Porta e frontal de 10 mm de espessura nivelados e cortados por laser

Trincos superiores e inferiores

Mecánicas

Key & Mechanical combination

Chave e combinação



Apertura con llave
Key opening



Secreto
Mechanical combination



Cierre con bulones
Locking bolts

101 M Plus 4 bulones / Bolts
102 M Plus 4 bulones / Bolts
103 M Plus 8 bulones / Bolts
104 M Plus 8 bulones / Bolts



101 M plus						
	alto	ancho	fondo	kg	litros	Ref.
Ext.	270	380	230	20	11	05431
Int.	171	333	180			

102 M plus						
	alto	ancho	fondo	kg	litros	Ref.
Ext.	320	428	230	24	14	05432
Int.	222	354	180			

103 M plus						
	alto	ancho	fondo	kg	litros	Ref.
Ext.	410	515	230	37	27	05433
Int.	311	470	180			

104 M plus						
	alto	ancho	fondo	kg	litros	Ref.
Ext.	515	420	315	40	41	05434
Int.	416	365	265			

100 E

EMPOTRAR

WALL SAFES / COFRES DE EMBUTIR



102 E

Electrónicas
Electronic system
Eletrônica

Apertura con llave
Key opening

Apertura electrónica
Electronic opening

S.O.S. Apertura de emergencia
Emergency opening

Cierre con bulones
Locking bolts

101 E 2 bulones / Bolts
102 E 2 bulones / Bolts
103 E 4 bulones / Bolts
104 E 4 bulones / Bolts

PUERTA 6 mm
Chapa de acero
Door Thickness

CUERPO 2 mm
Chapa de acero
Body Thickness

CERCO 4 mm
Chapa de acero
Frame Thickness

Receptora
Slot
105 EB



101 E						
	alto	ancho	fondo	kg	litros	Ref.
Ext.	240	350	220	11	8	13001
Int.	160	310	165			

102 E						
	alto	ancho	fondo	kg	litros	Ref.
Ext.	290	370	220	13	11	13002
Int.	210	335	165			

103 E						
	alto	ancho	fondo	kg	litros	Ref.
Ext.	380	485	220	20	22	13003
Int.	300	450	165			

104 E						
	alto	ancho	fondo	kg	litros	Ref.
Ext.	485	380	310	22	35	13004
Int.	405	345	255			

105 EB						
	alto	ancho	fondo	kg	litros	Ref.
Ext.	600	380	310	26	33	13034
Int.	415	320	250			

100 E plus

EMPOTRAR

WALL SAFES / COFRES DE EMBUTIR



103 E plus

Electrónicas
Electronic system
Eletrônica

Apertura con llave
Key opening

Apertura electrónica
Electronic opening

S.O.S. Apertura de emergencia
Emergency opening

Cierre con bulones
Locking bolts

101 E Plus 4 bulones / Bolts
102 E Plus 4 bulones / Bolts
103 E Plus 8 bulones / Bolts
104 E Plus 8 bulones / Bolts

PUERTA 10 mm
Chapa de acero
Door Thickness

CUERPO 2 mm
Chapa de acero
Body Thickness

CERCO 10 mm
Chapa de acero
Frame Thickness



101 E plus						
	alto	ancho	fondo	kg	litros	Ref.
Ext.	270	380	230	20	11	13043
Int.	171	333	180			

102 E plus						
	alto	ancho	fondo	kg	litros	Ref.
Ext.	320	428	230	24	14	13044
Int.	222	354	180			

103 E plus						
	alto	ancho	fondo	kg	litros	Ref.
Ext.	410	515	230	37	27	13045
Int.	311	470	180			

104 E plus						
	alto	ancho	fondo	kg	litros	Ref.
Ext.	515	428	315	40	41	13046
Int.	416	365	265			

Puerta y frontal de 10 mm de espesor, enrasados y cortados por láser

Bulones superiores e inferiores

Door and frame of 10 mm thickness laser cutting
Up and down bolts

Porta e frontal de 10 mm de espessura nivelados e cortados por laser
Trincos superiores e inferiores

9081 suelo

EMPOTRAR

FLOOR SAFES / COFRES DE EMBUTIR



9081 EASD



9081 EAS

Cajas para empotrar en el suelo
 Sistema electrónico: EAS / EASD
 Sistema mecánico: AS / ASD
 2 fondos disponibles

Safes to install in floor
 Electronic system: EAS / EASD
 Key and mechanical combination system: AS / ASD
 Available 2 different depths

Cofre fuerte para embutir no solo
 Sistema electrónico: EAS / EASD
 Sistema mecánico: AS / ASD
 2 fondos disponibles

Mecánicas y electrónicas Mechanical & electronic combination Combinação y eletrônica



Apertura con llave
 Key opening



Secreto
 Mechanical combination
 9081 AS, 9081 ASD



Apertura electrónica
 Electronic opening
 9081 EAS, 9081 EASD

S.O.S.

Apertura de emergencia
 Emergency opening
 9081 EAS, 9081 EASD



Cierre con bulones
 Locking bolts
 2 bulones / Bolts



8 mm
 Chapa de acero
 Door Thickness



2 mm
 Chapa de acero
 Body Thickness



2 mm
 Chapa de acero
 Frame Thickness



9081 AS						
	alto	ancho	fondo	kg	litros	Ref.
Ext.	280	350	155	11	7	04386
Int.	245	320	85			

9081 ASD						
	alto	ancho	fondo	kg	litros	Ref.
Ext.	280	350	290	14	16	04387
Int.	245	320	210			

9081 EAS						
	alto	ancho	fondo	kg	litros	Ref.
Ext.	280	350	155	11	7	13030
Int.	245	320	85			

9081 EASD						
	alto	ancho	fondo	kg	litros	Ref.
Ext.	280	350	290	14	16	13031
Int.	245	320	210			



100 E plus telescópica

EMPOTRAR

WALL SAFES / COFRES DE EMBUTIR

Pletinas de fijación extra

Fondo telescópico regulable

Puerta y frontal de 10 mm de espesor, enrasados y cortados por láser



Electrónicas
Electronic system
Eletrônica

104 E plus telescópica



Apertura con llave
Key opening



Apertura electrónica
Electronic opening

S.O.S.

Apertura de emergencia
Emergency opening



Cierre con bulones
Locking bolts

101 E Plus Telesc. 4 bulones / Bolts
102 E Plus Telesc. 4 bulones / Bolts
103 E Plus Telesc. 8 bulones / Bolts
104 E Plus Telesc. 8 bulones / Bolts



10 mm
Chapa de acero
Door Thickness



2 mm
Chapa de acero
Body Thickness



10 mm
Chapa de acero
Frame Thickness

101 E plus telesc.						
	alto	ancho	fondo	kg	litros	Ref.
Ext.	270	380	160-245	17	6-11	13055
Int.	171	333	110-195			

102 E plus telesc.						
	alto	ancho	fondo	kg	litros	Ref.
Ext.	320	428	160-245	22	8-15	13056
Int.	222	354	110-195			

103 E plus telesc.						
	alto	ancho	fondo	kg	litros	Ref.
Ext.	410	515	195-310	35	21-38	13057
Int.	311	470	145-260			

104 E plus telesc.						
	alto	ancho	fondo	kg	litros	Ref.
Ext.	515	428	195-310	36	22-39	13058
Int.	416	365	145-260			



102 E rasha

Electrónicas
Electronic system
Eletrônica



Pomo
Knob / manípulo



Apertura electrónica
Electronic opening

S.O.S.

Apertura de emergencia
Emergency opening



Cierre con bulones
Locking bolts

101 E Rasha 2 bulones / Bolts
102 E Rasha 4 bulones / Bolts
103 E Rasha 8 bulones / Bolts
104 E Rasha 8 bulones / Bolts



10 mm
Chapa de acero
Door Thickness



2 mm
Chapa de acero
Body Thickness



10 mm
Chapa de acero
Frame Thickness



101 E rasha						
	alto	ancho	fondo	kg	litros	Ref.
Ext.	270	380	230	20	11	36001
Int.	171	333	180			



102 E rasha						
	alto	ancho	fondo	kg	litros	Ref.
Ext.	320	428	230	24	14	36002
Int.	222	354	180			



103 E rasha						
	alto	ancho	fondo	kg	litros	Ref.
Ext.	410	515	230	37	27	36003
Int.	311	470	180			



104 E rasha						
	alto	ancho	fondo	kg	litros	Ref.
Ext.	515	428	315	40	41	36004
Int.	416	365	265			

100 E rasha

EMPOTRAR

WALL SAFES / COFRES DE EMBUTIR

Puerta y frontal de 10 mm de espesor, enrasados y cortados por láser
Bulones superiores e inferiores
Dotada con cerradura electrónica de seguridad homologada según UNE-EN 1300

Door and frame of 10 mm thickness laser cutting
Up and down bolts
Security electronic lock approved according to the standard UNE-EN 1300

Porta e frontal de 10 mm de espessura nivelados e cortados por laser
Trincos superiores e inferiores
Equipada com uma fechadura eletrónica de segurança homologada de acordo com a UNE-EN 1300

100 E rasha telescópica

EMPOTRAR

WALL SAFES / COFRES DE EMBUTIR



102 E rasha telescópica

Electrónicas
Electronic system
Eletrônica

Pomo
Knob / manipulo

Apertura electrónica
Electronic opening

S.O.S. Apertura de emergencia
Emergency opening

Cierre con bulones
Locking bolts



Receptora
Slot
105 EB Rasha telesc.



PUERTA 10 mm
Chapa de acero
Door Thickness



CUERPO 2 mm
Chapa de acero
Body Thickness



CERCO 10 mm
Chapa de acero
Frame Thickness

101 E Rasha Telesc. 2 bulones / Bolts
102 E Rasha Telesc. 4 bulones / Bolts
103 E Rasha Telesc. 8 bulones / Bolts
104 E Rasha Telesc. 8 bulones / Bolts



101 E rasha telesc.						
	alto	ancho	fondo	kg	litros	Ref.
Ext.	270	380	160-245	17	6-11	36021
Int.	171	333	110-195			



102 E rasha telesc.						
	alto	ancho	fondo	kg	litros	Ref.
Ext.	320	428	160-245	22	8-15	36022
Int.	222	354	110-195			



103 E rasha telesc.						
	alto	ancho	fondo	kg	litros	Ref.
Ext.	410	515	195-310	35	21-38	36023
Int.	311	470	145-260			



104 E rasha telesc.						
	alto	ancho	fondo	kg	litros	Ref.
Ext.	515	428	195-310	36	22-39	36024
Int.	416	365	145-260			



105 E rasha telesc.						
	alto	ancho	fondo	kg	litros	Ref.
Ext.	605	430	325-500	49	50-82	36025
Int.	500	365	275-450			



105 EB rasha telesc.						
	alto	ancho	fondo	kg	litros	Ref.
Ext.	605	430	325-500	49	50-82	36026
Int.	500	365	275-450			



106 E rasha telesc.						
	alto	ancho	fondo	kg	litros	Ref.
Ext.	605	561	325-500	59	65-107	36028
Int.	492	485	275-450			

Puerta y frontal de 10 mm de espesor, enrasados y cortados por láser
Bulones superiores e inferiores
Dotada con cerradura electrónica de seguridad homologada según UNE-EN 1300

Door and frame of 10 mm thickness laser cutting
Up and down bolts
Security electronic lock approved according to the standard UNE-EN 1300

Porta e frontal de 10 mm de espessura nivelados e cortados por laser
Trincos superiores e inferiores
Equipada com uma fechadura eletrônica de segurança homologada de acordo com a UNE-EN 1300

MARCO rasha

EMPOTRAR

WALL SAFES / COFRES DE EMBUTIR



marco 106 E rasha

Electrónicas
Electronic system
Eletrônica

S.O.S. Apertura de emergencia
Emergency opening

Cierre con bulones
Locking bolts



Pomo
Knob / manipulo



Apertura electrónica
Electronic opening

marco 103 E Rasha 8 bulones / Bolts
marco 104 E Rasha 8 bulones / Bolts
marco 106 E Rasha 8 bulones / Bolts



PUERTA 10 mm
Chapa de acero
Door Thickness



CERCO 10 mm
Chapa de acero
Frame Thickness



marco 103 E rasha				
	alto	ancho	kg	Ref.
Ext.	410	515	27,5	36123
Int.	311	470		



marco 104 E rasha				
	alto	ancho	kg	Ref.
Ext.	515	428	28,5	36124
Int.	416	365		



marco 106 E rasha				
	alto	ancho	kg	Ref.
Ext.	605	561	48	36128
Int.	492	485		



100 IE sistema integral

EMPOTRAR

WALL SAFES / COFRES DE EMBUTIR

Puerta corredera integral sin bulones. Sistema patentado

Sliding door without bolts. Patented locking system

Porta deslizante integral sem trincos. Sistema patenteado

103 IE

Electrónicas motorizadas
Electronic motorised
Eletrônica motorizada



Apertura electrónica
Electronic opening

S.O.S.

Apertura de emergencia
Emergency opening

integral

Sistema de cierre integral
Locking system no bolts



PUERTA 6 mm
Chapa de acero
Door Thickness



CUERPO 2 mm
Chapa de acero
Body Thickness



CERCO 4 mm
Chapa de acero
Frame Thickness



101 IE						
	alto	ancho	fondo	kg	litros	Ref.
Ext.	240	350	220	11	7	19000
Int.	160	310	150			



102 IE						
	alto	ancho	fondo	kg	litros	Ref.
Ext.	290	370	220	13,5	10	19001
Int.	210	335	150			



103 IE						
	alto	ancho	fondo	kg	litros	Ref.
Ext.	380	485	220	22	20	19002
Int.	300	450	150			



104 IE						
	alto	ancho	fondo	kg	litros	Ref.
Ext.	485	380	310	25,5	34	19003
Int.	405	345	240			

100 IE evolución sistema integral

EMPOTRAR

WALL SAFES / COFRES DE EMBUTIR

Puerta corredera integral sin bulones

Sistema patentado

Chapa antitaladro de acero al manganeso

Puerta y cerco de 8 mm de espesor

Acabado en 3 colores

Sliding door without bolts

Patented locking system

Antidrill manganese steel plate

Door and frame: 8 mm thickness

Available 3 colours finish

Porta deslizante integral sem trincos

Sistema patenteado

Chapa anti-perfuração em aço manganês

Porta de 8 mm de espessura

Acabamento disponível em 3 cores



103 IE evolución



Electrónicas motorizadas
Electronic motorised
Eletrônica motorizada



Apertura electrónica
Electronic opening

S.O.S.

Apertura de emergencia
Emergency opening

integral

Sistema de cierre integral
Locking system no bolts



PUERTA 8 mm
Chapa de acero
Door Thickness



CUERPO 2 mm
Chapa de acero
Body Thickness



CERCO 8 mm
Chapa de acero
Frame Thickness



101 IE evolución						
	alto	ancho	fondo	kg	litros	Ref.
Ext.	240	350	220	14	7,5	19040 gris
Int.	160	310	150			19050 verde
						19060 azul



102 IE evolución						
	alto	ancho	fondo	kg	litros	Ref.
Ext.	290	370	220	17,5	10,5	19041 gris
Int.	210	330	150			19051 verde
						19061 azul



103 IE evolución						
	alto	ancho	fondo	kg	litros	Ref.
Ext.	380	485	225	26	20,5	19042 gris
Int.	300	455	150			19052 verde
						19062 azul



104 IE evolución						
	alto	ancho	fondo	kg	litros	Ref.
Ext.	485	380	310	29	33,5	19043 gris
Int.	405	345	240			19053 verde
						19063 azul



TALAVERA

EMPOTRAR

WALL SAFES / COFRES DE EMBUTIR

Puerta y frontal de 10 mm de espesor, enrasados y cortados por láser
Bulones superiores e inferiores

Dotada de cerradura para cilindro de perfil europeo leva 15 mm

Door and frame of 10 mm thickness laser cutting
Up and down bolts

Porta e frontal de 10 mm de espessura nivelados e cortados por lase
Trincos superiores e inferiores

Mecánicas sólo llave

Key only

Com chave



Pomo
Knob / manípulo



Apertura con llave
Key opening



Cilindro perfil europeo 30 x 10
European profile cylinder 30 x 10



Cierre con bulones
Locking bolts

101	2 bulones / Bolts
102	4 bulones / Bolts
103	8 bulones / Bolts
104	8 bulones / Bolts

104 LL Talavera

PUERTA 10 mm
Chapa de acero
Door Thickness

CUERPO 2 mm
Chapa de acero
Body Thickness

CERCO 10 mm
Chapa de acero
Frame Thickness



101 LL talavera						
	alto	ancho	fondo	kg	litros	Ref.
Ext.	270	380	230	20	11	05021
Int.	171	333	180			

102 LL talavera						
	alto	ancho	fondo	kg	litros	Ref.
Ext.	320	428	230	24	14	05022
Int.	222	354	180			

103 LL talavera						
	alto	ancho	fondo	kg	litros	Ref.
Ext.	410	515	230	37	27	05023
Int.	311	470	180			

104 LL talavera						
	alto	ancho	fondo	kg	litros	Ref.
Ext.	515	428	315	40	41	05024
Int.	416	365	265			



redbox 3E

con LUZ INTERIOR



redbox 2E

Electrónicas

Electronic system

Eletrônica



Apertura con llave
Key opening



Apertura electrónica
Electronic opening

S.O.S.

Apertura de emergencia
Emergency opening



Cierre con bulones
Locking bolts

RB 2E	2 bulones / Bolts
RB 3E	3 bulones / Bolts

PUERTA 6 mm
Chapa de acero
Door Thickness

CUERPO 2 mm
Chapa de acero
Body Thickness

RED BOX 2-E						
	alto	ancho	fondo	kg	litros	Ref.
Ext.	319	418	219	16	12,5	44002
Int.	215	334	174			

RED BOX 3-E						
	alto	ancho	fondo	kg	litros	Ref.
Ext.	428	533	219	23	24	44003
Int.	305	446	176			

RED BOX 4-E						
	alto	ancho	fondo	kg	litros	Ref.
Ext.	534	428	313	25	38	44004
Int.	415	344	268			

redbox

EMPOTRAR

WALL SAFES / COFRES DE EMBUTIR

puerta y frontal de 6 mm
cortados por laser

102 Preinstalación, cajas + cajón

EMPOTRAR
WALL SAFES / COFRES DE EMBUTIR



102 LL preinstalación



102 IE preinstalación



102 E preinstalación



cajón preinstalación



Sistema especial para preinstalación en obra

Ventajas: instalación limpia y sencilla. Las cajas se fijan al cajón mediante 2 tornillos métrica de 8 incluidos

Special installation system for building

Advantages: Easy and clean installation. Safes are fixed inside the box with 2 screws included

Sistema especial de pré-instalação em obra

Vantagens: instalação fácil e limpa. Os cofres fortes fixam-se ás caixaz de pré-instalação em obra através de 2 parafusos

Mecánicas y electrónicas

Mechanical & electronic combination

Combinação y eletrônica



Apertura con llave
Key opening
102 LL Preinstalación
102 E Preinstalación



Apertura electrónica
Electronic opening
102 E Preinstalación
102 IE Preinstalación

S.O.S.

Apertura de emergencia
Emergency opening
102 E Preinstalación
102 IE Preinstalación



Sistema de cierre integral
Locking system no bolts



Cierre con bulones
Locking bolts

102 LL Preinst. 2 bulones / Bolts
102 E Preinst. 2 bulones / Bolts

PUERTA 6 mm
Chapa de acero
Door Thickness

CUERPO 2 mm
Chapa de acero
Body Thickness

CERCO 4 mm
Chapa de acero
Frame Thickness



Cajón 102 preinstalación

	alto	ancho	fondo	Ref.
Ext.	275	375	220	05905

102 LL preinstalación

	alto	ancho	fondo	kg	litros	Ref.
Ext.	300	405	220	14,6	11	05504
Int.	210	335	165			

102 E preinstalación

	alto	ancho	fondo	kg	litros	Ref.
Ext.	300	405	220	15,6	11	13064
Int.	210	335	165			

102 IE preinstalación

	alto	ancho	fondo	kg	litros	Ref.
Ext.	300	405	220	15,6	11	19102
Int.	210	335	165			

102 BR

EMPOTRAR

WALL SAFES / COFRES DE EMBUTIR



102 LL BR



102 IE BR



102 E BR

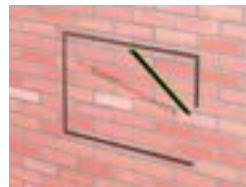

Mecánicas y electrónicas

Mechanical & electronic combination

Combinação e eletrônica



Apertura con llave
Key opening
102 LL Preinstalación
102 E Preinstalación



Apertura electrónica
Electronic opening
102 E Preinstalación
102 IE Preinstalación

S.O.S.

Apertura de emergencia
Emergency opening
102 E Preinstalación
102 IE Preinstalación



Sistema de cierre integral
Locking system no bolts



Cierre con bulones
Locking bolts

102 LL Preinst. 2 bulones / Bolts
102 E Preinst. 2 bulones / Bolts



6 mm
Chapa de acero
Door Thickness



2 mm
Chapa de acero
Body Thickness



4 mm
Chapa de acero
Frame Thickness

Instalación limpia y sencilla. La caja se fija a la pared mediante dos pletinas de acero, recubriéndose el hueco existente entre la caja y la pared con espuma de poliuretano (o similar) inyectada a través de los orificios del cerco

Easy and clean installation. The safe is fixed to the wall with two steel strips. The space between the safe and the wall is filled with polyurethane foam (or similar) injected through the holes in the frame

Instalação limpa e simples. O cofre fixa-se à parede a través de duas placas de aço, enchendo-se o espaço existente entre o cofre e a parede com espuma de poliuretano (ou similar) injectada a través dos orifícios do frontal do cofre



102 LL BR						
	alto	ancho	fondo	kg	litros	Ref.
Ext.	300	405	220	15	11	05508
Int.	210	335	165			



102 E BR						
	alto	ancho	fondo	kg	litros	Ref.
Ext.	300	405	220	16	11	13068
Int.	210	335	165			



102 IE BR						
	alto	ancho	fondo	kg	litros	Ref.
Ext.	300	405	220	16	11	19106
Int.	210	335	165			

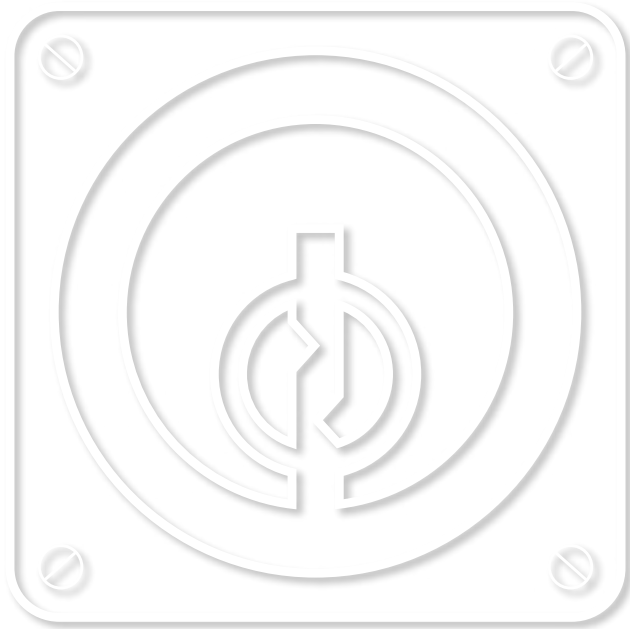



cajas fuertes de sobreponer

FREE STANDING SAFES · COFRES SUPERFICIE

FAC

ÍNDICE ICONOGRÁFICO



Apertura con llave
Key opening
Abertura com chave



Apertura electrónica
Electronic opening
Abertura eletrónica



Apertura con mando
Telecomand opening
Abertura com comando



Secreto
Mechanical combination
Combinação numérica



Pomo
Knob
Manípulo



Volante
Wheel
Volante



Maneta
Handle
Maçaneta



Cierre con bulones
Locking bolts
Fecho com linguetas



Cierre integral
Locking no bolts
Fecho integral



Receptora
Slot
Ranhura



Puerta de chapa de acero
Door thickness
Porta em chapa de aço



Cuerpo de chapa de acero
Body thickness
Corpo em chapa de aço



Cerco de chapa de acero
Frame thickness
Frontal em chapa de aço

S.O.S.

Apertura de emergencia
Emergency opening
Abertura de emergencia

Algunos modelos con apertura electrónica están dotados con llave de emergencia que permite abrir la caja en los supuestos de agotamiento o ausencia de pilas y también en caso de fallo del sistema electrónico.

Some models with electronic opening system have emergency key in case of batteries run down.

Alguns modelos com abertura electrónica dispõem de chave de emergência para abrir o cofre forte em caso de esgotamento das pilhas.

SISTEMAS MECÁNICOS

MECHANIC SYSTEMS / SISTEMAS MECÁNICOS



Cerradura de gorgas con llave de doble paletón con 8 claves

Levers key lock

Fechadura de gorges com chave de palhetão de 8 pinos

Serie: 100 LL, 100 SLL, 100 ILL
Modelo: 105 LLB, 105 SLL
Librería Buro 1812, Época 1931



Llave de doble paletón y combinación mecánica (secreto)



Levers key & mechanical combination

Chave de duplo palhetão e manípulo de combinação numérica

Serie: 100 M, 100 MS
Serie: 105 MB, 105 MSB
Modelo: 9081



Llave de doble paletón, combinación numérica (secreto) y volante



Levers key, mechanical combination & wheel



Chave de duplo palhetão e manípulo de combinação numérica e volante

Serie: 2083 B/C
Serie: 3083 B/C



Cilindro de latón protegido

Protected brass cylinder

Cilindro de latão protegido

Modelo: 901 J, 100 mini LL, 6570 C/T



Cerradura de gorgas clase A o B Normativa VDS/EN 1303

Levers lock class A or B VDS/EN 1303 certification

Fechadura de gorges clase A ou B Normativa VDS/EN 1303

Serie: SAFARI, ÉLITE, ÉLITE 2LL, M y E, ALFA, GREDOS, TARGET, ARMARIO AR y PETRA



Apertura con llave
Key opening

SISTEMAS ELECTRÓNICOS

ELECTRONIC SYSTEMS / SISTEMAS ELETRÓNICOS



Llave de doble paletón combinación electrónica y sistema de emergencia



Levers key, electronic combination and emergency system

S.O.S.

Chave de duplo palhetão, combinação eletrónica e sistema de emergência

Serie: 100 E, 100 ES
Serie: 9081 EAS/EASD
Serie: Plus



Pomo, combinación electrónica y sistema de emergencia



Knob, electronic combination and emergency system

Manípulo, combinação eletrónica e sistema de emergência

S.O.S.

Serie: 100 ESP
Serie: 100 ESPH
Serie: 100 Rasha



Electrónica motorizada y sistema de emergencia

Electronic motorised system & emergency system

S.O.S.

Abertura electrónica motorizada e sistema de emergência

Serie: 100 IE, 100 IES, 100 IES evolución
Serie: 400
Modelo: 100 EPC



Apertura eletrónica con mando a distancia por infrarrojos y sistema de emergencia

Electronic opening system con remote control and emergency system

S.O.S.

Abertura electrónica com comando à distância e sistema de emergência

Modelo: Época 1931



102 SLL

Mecánicas sólo llave
Key only
Com chave

Apertura con llave
Key opening

Cierre con bulones
Locking bolts

- 101 SLL 2 bulones / Bolts
- 102 SLL 2 bulones / Bolts
- 103 SLL 4 bulones / Bolts
- 104 SLL 4 bulones / Bolts

PUERTA 6 mm
Chapa de acero
Door Thickness

CUERPO 2 mm
Chapa de acero
Body Thickness



101 MS

Mecánicas
Key & Mechanical combination
Chave e combinação

Apertura con llave
Key opening

Secreto
Mechanical combination

Cierre con bulones
Locking bolts

- 101 MS 2 bulones / Bolts
- 102 MS 2 bulones / Bolts
- 103 MS 4 bulones / Bolts
- 104 MS 4 bulones / Bolts

PUERTA 6 mm
Chapa de acero
Door Thickness

CUERPO 2 mm
Chapa de acero
Body Thickness

100 SLL

SOBREPONER

FREE STANDING SAFES / COFRES SUPERFICIE



101 SLL						
	alto	ancho	fondo	kg	litros	Ref.
Ext.	240	350	220	13	12	05441
Int.	235	345	150			



102 SLL						
	alto	ancho	fondo	kg	litros	Ref.
Ext.	290	370	350	18	29	05442
Int.	285	365	280			



103 SLL						
	alto	ancho	fondo	kg	litros	Ref.
Ext.	380	485	350	26	50	05443
Int.	375	480	280			



104 SLL						
	alto	ancho	fondo	kg	litros	Ref.
Ext.	485	380	350	26	50	05444
Int.	480	375	280			

100 MS

SOBREPONER

FREE STANDING SAFES / COFRES SUPERFICIE



101 MS						
	alto	ancho	fondo	kg	litros	Ref.
Ext.	240	350	220	13	12	05453
Int.	235	345	150			



102 MS						
	alto	ancho	fondo	kg	litros	Ref.
Ext.	290	370	350	18	29	05454
Int.	285	365	280			



103 MS						
	alto	ancho	fondo	kg	litros	Ref.
Ext.	380	485	350	26	50	05455
Int.	375	480	280			



104 MS						
	alto	ancho	fondo	kg	litros	Ref.
Ext.	485	380	350	26	50	05456
Int.	480	375	280			

Provistas de serie con cuatro orificios en la base y tres en el fondo para su fijación al suelo y pared respectivamente
Supplied with four holes in the base to be fixed to the floor and three holes at the bottom to be fixed to the wall
Fornecida de série com quatro orificios na base e três no fundo para a sua fixação ao solo e parede respectivamente



103 MS plus

Puerta y frontal de 10 mm de espesor, enrasados y cortados por láser. Bulones superiores e inferiores

Door and frame of 10 mm thickness laser cutting. Up and down bolts

Porta e frontal de 10 mm de espessura nivelados e cortados por laser. Trincos superiores e inferiores

Mecánicas

Key & Mechanical combination

Chave e combinação



Apertura con llave
Key opening



Secreto
Mechanical combination



Cierre con bulones
Locking bolts

101 MS Plus	4 bulones / Bolts
102 MS Plus	4 bulones / Bolts
103 MS Plus	8 bulones / Bolts
104 MS Plus	8 bulones / Bolts



Receptora
Slot
102 MSB Plus
104 MSB Plus



10 mm
Chapa de acero
Door Thickness



3 mm
Chapa de acero
Body Thickness



101 ES

Electrónicas

Electronic system

Eletrónica



Apertura con llave
Key opening



Apertura electrónica
Electronic opening

S.O.S.

Apertura de emergencia
Emergency opening



Apertura de emergencia
Emergency opening

101 E	2 bulones / Bolts
102 E	2 bulones / Bolts
103 E	4 bulones / Bolts
104 E	4 bulones / Bolts



6 mm
Chapa de acero
Door Thickness



2 mm
Chapa de acero
Body Thickness

100 MS plus

SOBREPONER

FREE STANDING SAFES / COFRES SUPERFICIE



101 MS plus

	alto	ancho	fondo	kg	litros	Ref.
Ext.	274	387	220	23	17	05419
Int.	268	381	169			



102 MS plus

	alto	ancho	fondo	kg	litros	Ref.
Ext.	324	435	355	41	41	05420
Int.	318	429	304			



102 MSB plus

	alto	ancho	fondo	kg	litros	Ref.
Ext.	324	435	355	41	41	05520
Int.	318	429	304			
Int.	210	335	165			



103 MS plus

	alto	ancho	fondo	kg	litros	Ref.
Ext.	414	522	350	48	63	05421
Int.	408	516	299			



104 MS plus

	alto	ancho	fondo	kg	litros	Ref.
Ext.	519	435	355	46	67	05422
Int.	513	429	304			



104 MSB plus

	alto	ancho	fondo	kg	litros	Ref.
Ext.	519	435	355	46	67	05522
Int.	513	429	304			

100 ES

SOBREPONER

FREE STANDING SAFES / COFRES SUPERFICIE



101 ES

	alto	ancho	fondo	kg	litros	Ref.
Ext.	240	350	220	12	12	13005
Int.	235	345	150			



102 ES

	alto	ancho	fondo	kg	litros	Ref.
Ext.	290	370	350	17	29	13006
Int.	285	365	280			



103 ES

	alto	ancho	fondo	kg	litros	Ref.
Ext.	380	485	350	26	50	13007
Int.	375	480	280			



104 ES

	alto	ancho	fondo	kg	litros	Ref.
Ext.	485	380	350	28	50	13008
Int.	480	375	280			

Provistas de serie con cuatro orificios en la base y tres en el fondo para su fijación al suelo y pared respectivamente

Supplied with four holes in the base to be fixed to the floor and three holes at the bottom to be fixed to the wall

Fornecida de série com quatro orifícios na base e três no fundo para a sua fixação ao solo e parede respectivamente

100 ES plus

SOBREPONER

FREE STANDING SAFES / COFRES SUPERFICIE



103 ES plus

Puerta y frontal de 10 mm de espesor, enrasados y cortados por láser. Bulones superiores e inferiores

Door and frame of 10 mm thickness laser cutting. Up and down bolts

Porta e frontal de 10 mm de espessura nivelados e cortados por laser. Trincos superiores e inferiores

Electrónicas

Electronic system

Eletrônica

 Apertura con llave
Key opening

 Apertura electrónica
Electronic opening

S.O.S. Apertura de emergencia
Emergency opening

 Receptora
Slot
102 ESB Plus
103 ESB Plus
104 ESB Plus

 Cierre con bulones
Locking bolts

101 ES Plus 4 bulones / Bolts
102 ES Plus 4 bulones / Bolts
103 ES Plus 8 bulones / Bolts
104 ES Plus 8 bulones / Bolts

PUERTA 10 mm
Chapa de acero
Door Thickness

CUERPO 3 mm
Chapa de acero
Body Thickness



101 ES plus

	alto	ancho	fondo	kg	litros	Ref.
Ext.	274	387	220	23	17	13047
Int.	268	381	169			



102 ES plus

	alto	ancho	fondo	kg	litros	Ref.
Ext.	324	435	355	32	41	13048
Int.	318	429	304			



102 ESB plus

	alto	ancho	fondo	kg	litros	Ref.
Ext.	324	435	355	32	41	13148
Int.	318	429	304			
Int.	210	335	165			



103 ES plus

	alto	ancho	fondo	kg	litros	Ref.
Ext.	414	522	350	48	63	13049
Int.	408	516	299			



103 ESB plus

	alto	ancho	fondo	kg	litros	Ref.
Ext.	414	522	350	48	63	13149
Int.	408	516	299			



104 ES plus

	alto	ancho	fondo	kg	litros	Ref.
Ext.	519	435	355	46	67	13050
Int.	513	429	304			



104 ESB plus

	alto	ancho	fondo	kg	litros	Ref.
Ext.	519	435	355	46	67	13150
Int.	513	429	304			



HEXA ES

Electrónicas

Electronic system

Eletrônica

 Apertura electrónica
Electronic opening

S.O.S. Apertura de emergencia
Emergency opening

 Cierre con bulones
Locking bolts
6 bulones / Bolts

PUERTA 15 mm
Chapa de acero
Door Thickness

CUERPO 4 mm
Chapa de acero
Body Thickness

Provista de serie con cuatro orificios en la base y tres en el fondo para su fijación al suelo y pared respectivamente
Supplied with four holes in the base to be fixed to the floor and three holes at the bottom to be fixed to the wall

Fornecida de série com quatro orifícios na base e três no fundo para a sua fixação ao solo e parede respectivamente



Hexa ES

	alto	ancho	fondo	kg	litros	Ref.
Ext.	335	415	350	40	37	13060
Int.	327	407	280			31512
						31513

gris claro

gris oscuro

vainilla



103 ES rasha

Puerta y frontal de 10 mm de espesor, enrasados y cortados por láser. Bulones superiores e inferiores. Dotada con cerradura electrónica de seguridad homologada según UNE-EN 1300

Door and frame of 10 mm thickness laser cutting. Up and down bolts. Security electronic lock approved according to the standard UNE-EN 1300

Porta e frontal de 10 mm de espessura nivelados e cortados por laser. Trincos superiores e inferiores. Equipada com uma fechadura eletrônica de segurança homologada de acordo com a UNE-EN 1300

Electrónicas

Electronic system

Eletrônica



Apertura con pomo
Key opening



Apertura electrónica
Electronic opening

S.O.S.

Apertura de emergencia
Emergency opening



Cierre con bulones
Locking bolts

101 ES Rasha 2 bulones / Bolts
102 ES Rasha 4 bulones / Bolts
103 ES Rasha 8 bulones / Bolts
104 ES Rasha 8 bulones / Bolts



PUERTA 10 mm
Chapa de acero
Door Thickness

CUERPO 3 mm
Chapa de acero
Body Thickness



Receptora
Slot
102 ESB Rasha
104 ESB Rasha

100 ES rasha

SOBREPONER

FREE STANDING SAFES / COFRES SUPERFICIE



101 ES rasha						
	alto	ancho	fondo	kg	litros	Ref.
Ext.	274	387	220	23	17	36011
Int.	268	381	169			



102 ES rasha						
	alto	ancho	fondo	kg	litros	Ref.
Ext.	324	435	355	32	41	36012
Int.	318	429	304			



102 ESB rasha						
	alto	ancho	fondo	kg	litros	Ref.
Ext.	324	435	355	32	41	36006
Int.	318	429	304			



103 ES rasha						
	alto	ancho	fondo	kg	litros	Ref.
Ext.	414	522	350	48	63	36013
Int.	408	516	299			



104 ES rasha						
	alto	ancho	fondo	kg	litros	Ref.
Ext.	519	435	355	46	67	36014
Int.	513	429	304			



104 ESB rasha						
	alto	ancho	fondo	kg	litros	Ref.
Ext.	519	435	355	46	67	36008
Int.	513	429	304			



100 AIR



100 E PC



100 LL PC

Electrónicas motorizada y solo llave

Electronic motorised and key only

Eletrônica motorizada e com chave



Apertura con llave
Key opening
100 LL PC

S.O.S.

Apertura de emergencia
Emergency opening
100 E PC



Apertura con pomo
Key opening
100 AIR



PUERTA 6 mm
Chapa de acero
Door Thickness



Apertura electrónica
Electronic opening
100 E PC, 100 AIR



Cierre con bulones
Locking bolts
2 bulones / Bolts



Cierre con resbalón
100 AIR



CUERPO 2 mm
Chapa de acero
Body Thickness

Provista de serie con cuatro orificios en la base y tres en el fondo para su fijación al suelo y pared respectivamente
Supplied with four holes in the base to be fixed to the floor and three holes at the bottom to be fixed to the wall
Fornecida de série com quatro orificios na base e três no fundo para a sua fixação ao solo e parede respectivamente

100 PC

SOBREPONER

FREE STANDING SAFES / COFRES SUPERFICIE



100 E PC						
	alto	ancho	fondo	kg	litros	Ref.
Ext.	200	420	370	16	25	13026
Int.	195	415	310			



100 LL PC						
	alto	ancho	fondo	kg	litros	Ref.
Ext.	200	420	370	16	25	05435
Int.	195	415	310			



100 AIR						
	alto	ancho	fondo	kg	litros	Ref.
Ext.	340	210	390	12,8	22	13061
Int.	336	206	330			



103 IES

Electrónicas motorizadas
Electronic motorised
Eletrônica motorizada



Apertura electrónica
Electronic opening

S.O.S.

Apertura de emergencia
Emergency opening



Sistema de cierre integral
Locking system no bolts



6 mm
Chapa de acero
Door Thickness

2 mm
Chapa de acero
Body Thickness

100 IES (sist. integral)

SOBREPONER

FREE STANDING SAFES / COFRES SUPERFICIE



101 IES						
	alto	ancho	fondo	kg	litros	Ref.
Ext.	240	350	220	12	11	19010
Int.	235	345	140			



102 IES						
	alto	ancho	fondo	kg	litros	Ref.
Ext.	290	370	350	18	28	19011
Int.	285	365	270			



103 IES						
	alto	ancho	fondo	kg	litros	Ref.
Ext.	380	485	350	26	48	19012
Int.	375	480	270			



104 IES						
	alto	ancho	fondo	kg	litros	Ref.
Ext.	485	380	350	26	48	19013
Int.	480	375	270			



103 IES evolución



100 IES evolución (sist. integral)

SOBREPONER

FREE STANDING SAFES / COFRES SUPERFICIE

Electrónicas motorizadas
Electronic motorised
Eletrônica motorizada



Apertura electrónica
Electronic opening

S.O.S.

Apertura de emergencia
Emergency opening



Sistema de cierre integral
Locking system no bolts



8 mm
Chapa de acero
Door Thickness

3 mm
Chapa de acero
Body Thickness



101 IES evolución						
	alto	ancho	fondo	kg	litros	Ref.
Ext.	240	350	220	17	11	19070 gris
						19080 verde
						19090 azul
Int.	233	343	137			



102 IES evolución						
	alto	ancho	fondo	kg	litros	Ref.
Ext.	290	370	350	25	28	19071 gris
						19081 verde
						19091 azul
Int.	283	363	267			



103 IES evolución						
	alto	ancho	fondo	kg	litros	Ref.
Ext.	380	485	350	39	48	19072 gris
						19082 verde
						19092 azul
Int.	373	478	267			



104 IES evolución						
	alto	ancho	fondo	kg	litros	Ref.
Ext.	485	380	350	39	48	19073 gris
						19083 verde
						19093 azul
Int.	478	373	267			

Provista de serie con cuatro orificios en la base y tres en el fondo para su fijación al suelo y pared respectivamente
Supplied with four holes in the base to be fixed to the floor and three holes at the bottom to be fixed to the wall
Fornecida de série com quatro orifícios na base e três no fundo para a sua fixação ao solo e parede respectivamente

NUEVO



RED BOX ESP SOBREPONER



Electrónicas
Electronic system
Eletrônica

con LUZ INTERIOR



Apertura con pomo
Key opening



6 mm
Chapa de acero
Door Thickness



Apertura electrónica
Electronic opening
RB 2ES, 3ES, 4ES



2 mm
Chapa de acero
Body Thickness

S.O.S.

Apertura de emergencia
Emergency opening



Cierre con bulones RB 2ES, 2SLL 2 bulones / Bolts
Locking bolts RB 3ES, 4ES, 3SLL, 4SLL 3 bulones / Bolts

Provista de serie con cuatro orificios en la base y tres en el fondo para su fijación al suelo y pared respectivamente

Supplied with four holes in the base to be fixed to the floor and three holes at the bottom to be fixed to the wall

Fornecida de série com quatro orifícios na base e três no fundo para a sua fixação ao solo e parede respectivamente

RED BOX 2 ESP

	alto	ancho	fondo	kg	litros	Ref.
Ext.	323	422	354	21	41	44017
Int.	319	418	310			

RED BOX 3 ESP

	alto	ancho	fondo	kg	litros	Ref.
Ext.	432	537	350	30	70	44018
Int.	428	533	306			

RED BOX 4 ESP

	alto	ancho	fondo	kg	litros	Ref.
Ext.	538	432	350	34	69	44019
Int.	534	428	305			

NUEVO



MOTORBLUE SOBREPONER FREE STANDING SAFES / COFRES SUPERFICIE

S.O.S.

Apertura de emergencia
Emergency opening



6 mm
Chapa de acero
Door Thickness

integral

Sistema de cierre integral
Locking system no bolts



2 mm
Chapa de acero
Body Thickness



Se gestiona a través del móvil.

Robusta y cómoda.

Tecnología segura y encriptada. Dos niveles de Seguridad: Protocolo y Aplicación.

Administra los usuarios y sus permisos. Registra las aperturas.



101 IES MOTORBLUE

	alto	ancho	fondo	kg	litros	Ref.
Ext.	240	350	220	12	11	19110
Int.	235	345	140			



102 IES MOTORBLUE

	alto	ancho	fondo	kg	litros	Ref.
Ext.	290	370	350	18	28	19111
Int.	285	365	270			



103 IES MOTORBLUE

	alto	ancho	fondo	kg	litros	Ref.
Ext.	380	485	350	26	48	19112
Int.	375	480	270			



104 IES MOTORBLUE

	alto	ancho	fondo	kg	litros	Ref.
Ext.	485	380	350	26	48	19113
Int.	480	375	270			

SOBREPONER FREE STANDING SAFES / COFRES SUPERFICIE



105 ESB

Buzón 180 x 12 mm
Slot / Ranhura

Mecánicas y electrónicas
Key & Mechanical combinatios
and electronic system
Chave e combinação e eletrônica



Apertura con llave
Key opening



Apertura electrónica
Electronic opening
105 ES, 105 ESB

S.O.S.

Apertura de emergencia
Emergency opening
105 ES, 105 ESB



Secreto
Mechanical combination
105 MS, 105 MSB



PUERTA 6 mm
Chapa de acero
Door Thickness



CUERPO 2 + 2 mm
Chapa de acero
Body Thickness



Receptora
Slot
105 SLLB
105 MSB
105 ESB



Cierre con bulones
Locking bolts



105 SLL						
	alto	ancho	fondo	kg	litros	Ref.
Ext.	605	385	355	101	44	05480
Int.	535	325	255			



105 MS						
	alto	ancho	fondo	kg	litros	Ref.
Ext.	605	385	355	101	44	05481
Int.	535	325	255			



105 ES						
	alto	ancho	fondo	kg	litros	Ref.
Ext.	605	385	355	101	44	13033
Int.	535	325	255			



CAJA LIGERA 105-ES L puerta gris claro						
	alto	ancho	fondo	kg	litros	Ref.
Ext.	605	385	355	63	44	13100
Int.	535	325	255			



105 SLLB						
	alto	ancho	fondo	kg	litros	Ref.
Ext.	605	385	355	101	30	05484
Int.	415	325	225			



105 MSB						
	alto	ancho	fondo	kg	litros	Ref.
Ext.	605	385	355	101	30	05485
Int.	415	325	225			



105 ESB						
	alto	ancho	fondo	kg	litros	Ref.
Ext.	605	385	355	101	30	13035
Int.	415	325	225			

Provista de serie con cuatro orificios en la base y tres en el fondo para su fijación al suelo y pared respectivamente
Supplied with four holes in the base to be fixed to the floor and three holes at the bottom to be fixed to the wall
Fornecida de série com quatro orifícios na base e três no fundo para a sua fixação ao solo e parede respectivamente



901 J



6570 T



6570 C

Cajas para camión y turismo 6570 C:
con ranura de 95x8 mm
6570 T: sin ranura
901 J: caja joyero

Safes special for truck and car
6570 C: with slot of 95x8 mm
6570 T: Without slot
901 J: Jewel safe

Mecánicas sólo llave
Key only
Com chave

Cofres para camiões e turismo
6570 C: com ranhura de 95x8 mm
6570 T: sem ranhura
901 J: Caixa porta-joias

6570 T/C • 901 J

SOBREPONER FREE STANDING SAFES / COFRES SUPERFICIE



6570 T						
	alto	ancho	fondo	kg	litros	Ref.
Ext.	230	230	150	3	7	05438
Int.	220	225	145			



6570 C						
	alto	ancho	fondo	kg	litros	Ref.
Ext.	230	230	150	3	7	05439
Int.	220	225	145			



901 J						
	alto	ancho	fondo	kg	litros	Ref.
Ext.	235	205	165	4	4	05440
Int.	175	145	160			



6570 T
6570 C
901 J



PUERTA 2 mm
Chapa de acero
Door Thickness



Receptora
Slot
6570 C



CUERPO Chapa de acero
Body Thickness
6570 T 2,5 mm
6570 C 2,5 mm
901 J 2 mm

105 / 106 / 107 plus

SOBREPONER

FREE STANDING SAFES / COFRES SUPERFICIE



Buzón 180 x 12 mm
Slot / Ranhura

105 ES plus

Mecánicas y electrónicas

Key & Mechanical combinatios and electronic system

Chave e combinação e eletrônica



Apertura con llave
Key opening



Cierre con bulones
Locking bolts
8 bulones / bolts



Apertura electrónica
Electronic opening
105 ES Plus
105 ESB Plus



Receptora
Slot
105 SLLB Plus
105 MSB Plus
105 ESB Plus

S.O.S.

Apertura de emergencia
Emergency opening
105 ES Plus
105 ESB Plus



10 mm
Chapa de acero
Door Thickness



Secreto
Mechanical combination
105 MS Plus
105 MSB Plus



2 + 2 mm
Chapa de acero
Body Thickness



105 SLL plus						
	alto	ancho	fondo	kg	litros	Ref.
Ext.	608	435	355	114	50	05488
Int.	520	368	264			



105 MS plus						
	alto	ancho	fondo	kg	litros	Ref.
Ext.	608	435	355	114	50	05487
Int.	520	368	264			



105 ES plus						
	alto	ancho	fondo	kg	litros	Ref.
Ext.	608	435	355	115	50	13032
Int.	520	368	264			



105 SLLB plus						
	alto	ancho	fondo	kg	litros	Ref.
Ext.	608	435	355	114	50	05489
Int.	510	368	264			



105 MSB plus						
	alto	ancho	fondo	kg	litros	Ref.
Ext.	608	435	355	114	50	05490
Int.	510	368	264			



105 ESB plus						
	alto	ancho	fondo	kg	litros	Ref.
Ext.	608	435	355	115	50	13041
Int.	510	368	264			



CAJA LIGERA 106-ES L plus puerta gris claro						
	alto	ancho	fondo	kg	litros	Ref.
Ext.	608	566	462	85	89	13101
Int.	492	481	374			



CAJA LIGERA 107-ES L plus puerta gris claro						
	alto	ancho	fondo	kg	litros	Ref.
Ext.	803	566	462	120	124	13103
Int.	687	481	374			

Provista de serie con cuatro orificios en la base y tres en el fondo para su fijación al suelo y pared respectivamente
Supplied with four holes in the base to be fixed to the floor and three holes at the bottom to be fixed to the wall
Fornecida de série com quatro orificios na base e três no fundo para a sua fixação ao solo e parede respectivamente



103

Solo llave

Key only

Com chave



Apertura con llave
Key opening



4 mm
Chapa de acero
Door Thickness



Cierre con bulones
Locking bolts
3 bulones / Bolts



1,5 + 1,5 mm
Chapa de acero
Body Thickness

Provista de serie con cuatro orificios en la base y tres en el fondo para su fijación al suelo y pared respectivamente
Supplied with four holes in the base to be fixed to the floor and three holes at the bottom to be fixed to the wall

Fornecida de série com quatro orificios na base e três no fundo para a sua fixação ao solo e parede respectivamente

CAJA VIDEOGRABADOR

SOBREPONER

FREE STANDING SAFES / COFRES SUPERFICIE



102 videograbador						
	alto	ancho	fondo	kg	litros	Ref.
Ext.	270	600	600	25	49	41201
Int.	178	506	539			



103 videograbador						
	alto	ancho	fondo	kg	litros	Ref.
Ext.	380	660	765	52	114	41203
Int.	288	564	704			



106 ES rasha

105 / 106 / 107 rasha

SOBREPONER
FREE STANDING SAFES / COFRES SUPERFICIE

Mecánicas y electrónicas Key & Mechanical combinatios and electronic system Chave e combinação e eletrônica



Pomo
Knob / manipulo



Apertura electrónica
Electronic opening



S.O.S. Apertura de emergencia
Emergency opening



Cierre con bulones
Locking bolts
8 bulones / Bolts



Receptora
Slot
105 ESB Rasha



10 mm
Chapa de acero
Door Thickness



2 + 2 mm
Chapa de acero
Body Thickness

105 ESL Rasha 4 mm
105 ES Rasha 2+2 mm
105 ESB Rasha 2+2 mm

Peana opcional
Optional pedestal
106 ES Rasha
107 ES Rasha

Provista de serie con cuatro orificios en la base y tres en el fondo para su fijación al suelo y pared respectivamente
Supplied with four holes in the base to be fixed to the floor and three holes at the bottom to be fixed to the wall
Fornecida de série com quatro oríficios na base e três no fundo para a sua fixação ao solo e parede respectivamente

Puerta y frontal de 10 mm de espesor, enrasados y cortados por láser. Cuerpo construido con doble chapa de acero de 2 mm relleno de mortero (excepto Mod. 105 ESL Rasha). Bulones superiores e inferiores. Dotada con cerradura electrónica de seguridad homologada según UNE-EN 1300

Door and frame of 10 mm thickness laser cutting. Body with double 2 mm steel plate filled with concrete (except for Mod. 105 ESL Rasha). Up and down bolts. Security electronic lock approved according to the standard UNE-EN 1300

Porta e frontal de 10 mm de espessura nivelados e cortados por laser. Corpo fabricado com dupla chapa de aço de 2 mm de espessura, enchimento de cimento (exceto Mod. 105 ESL Rasha). Trincos superiores e inferiores.

Equipada com uma fechadura eletrônica de segurança homologada de acordo com a UNE-EN 1300



105 ES rasha						
	alto	ancho	fondo	kg	litros	Ref.
Ext.	608	435	355	115	50	36015
Int.	520	368	264			



105 ESB rasha						
	alto	ancho	fondo	kg	litros	Ref.
Ext.	608	435	355	115	50	36016
Int.	510	368	264			



105 ESL rasha						
	alto	ancho	fondo	kg	litros	Ref.
Ext.	609	439	355	63	78	36017
Int.	601	431	303			



106 ES rasha						
	alto	ancho	fondo	kg	litros	Ref.
Ext.	608	566	462	160	89	36018
Int.	492	481	374			



106 ESB rasha						
	alto	ancho	fondo	kg	litros	Ref.
Ext.	608	566	460	160	89	36009
Int.	490	481	375			



107 ES rasha						
	alto	ancho	fondo	kg	litros	Ref.
Ext.	803	566	462	220	124	36019
Int.	687	481	374			



107 ESB rasha						
	alto	ancho	fondo	kg	litros	Ref.
Ext.	800	566	460	220	124	36010
Int.	685	481	375			



166 ES rasha

Peana opcional
Optional pedestal

Puerta y frontal de 10 mm de espesor, enrasados y cortados por láser. Bulones superiores e inferiores. Dotada con cerradura electrónica de seguridad homologada según UNE-EN 1300

Door and frame of 10 mm thickness laser cutting. Up and down bolts. Security electronic lock approved according to the standard UNE-EN 1300

Porta e frontal de 10 mm de espessura nivelados e cortados por laser. Trincos superiores e inferiores. Equipada com uma fechadura eletrônica de segurança homologada de acordo com a UNE-EN 1300

166 / 167 / 177 ES rasha

SOBREPONER

FREE STANDING SAFES / COFRES SUPERFICIE



166 ES rasha (doble cuerpo)						
	alto	ancho	fondo	kg	litros	Ref.
Ext.	1215	566	462	320	88/88	36030
Int.	492/492	481/481	374/374			



167 ES rasha (doble cuerpo)						
	alto	ancho	fondo	kg	litros	Ref.
Ext.	1410	566	462	380	88/123	36031
Int.	492/687	481/481	374/374			



177 ES rasha (doble cuerpo)						
	alto	ancho	fondo	kg	litros	Ref.
Ext.	1605	566	462	440	123/123	36032
Int.	687/687	481/481	374/374			

Electrónicas
Electronic system
Eletrônica



Apertura con pomo
Key opening



Apertura electrónica
Electronic opening

S.O.S.

Apertura de emergencia
Emergency opening



Cierre con bulones
Locking bolts

166 ES Rasha 8+8 bulones / Bolts
167 ES Rasha 8+8 bulones / Bolts
177 ES Rasha 8+8 bulones / Bolts



10 mm
Chapa de acero
Door Thickness



2 + 2 mm
Chapa de acero
Body Thickness



104 SLL Talavera

Puerta y frontal de 10 mm de espesor, enrasados y cortados por láser. Bulones superiores e inferiores. Dotada de cerradura para cilindro de perfil europeo leva 15 mm

Door and frame of 10 mm thickness laser cutting. Up and down bolts

Porta e frontal de 10 mm de espessura nivelados e cortados por laser. Trincos superiores e inferiores

Mecánicas sólo llave

Key only

Com chave



Pomo
Knob / manipul



Apertura con llave
Key opening



Cilindro perfil europeo 30 x 10
European profile cylinder 30 x 10



Cierre con bulones
Locking bolts

101 2 bulones / Bolts
102 4 bulones / Bolts
103 8 bulones / Bolts
104 8 bulones / Bolts

TALAVERA

SOBREPONER

FREE STANDING SAFES / COFRES SUPERFICIEz



101 SLL Talavera						
	alto	ancho	fondo	kg	litros	Ref.
Ext.	274	387	220	23	17	05001
Int.	268	381	169			



102 SLL Talavera						
	alto	ancho	fondo	kg	litros	Ref.
Ext.	324	435	355	41	41	05002
Int.	318	429	304			



103 SLL Talavera						
	alto	ancho	fondo	kg	litros	Ref.
Ext.	414	522	350	48	63	05003
Int.	408	516	299			



104 SLL Talavera						
	alto	ancho	fondo	kg	litros	Ref.
Ext.	519	435	355	46	67	05004
Int.	513	429	304			



105 L SLL Talavera						
	alto	ancho	fondo	kg	litros	Ref.
Ext.	609	439	355	63	78	05008
Int.	601	431	303			



10 mm
Chapa de acero
Door Thickness



2 mm
Chapa de acero
Body Thickness



10 mm
Chapa de acero
Frame Thickness

400 V2

SOBREPONER

FREE STANDING SAFES / COFRES SUPERFICIE



410 V2

Electrónicas motorizadas
Electronic motorised
Eletrônica motorizada



Cierre con bulones
Locking bolts
4 bulones / Bolts



Apertura electrónica
Electronic opening



10 mm
Chapa de acero
Door Thickness

S.O.S.

Apertura de emergencia
Emergency opening



2 + 2 mm
Chapa de acero
Body Thickness



410 V2

	alto	ancho	fondo	kg	litros	Ref.
Ext.*	710	642	482	179	89	13236
Int.	492	481	374			



420 V2

	alto	ancho	fondo	kg	litros	Ref.
Ext.*	910	642	482	239	125	13237
Int.	687	481	374			



411 V2 (doble cuerpo)

	alto	ancho	fondo	kg	litros	Ref.
Ext.*	1315	642	482	360	88/88	13238
Int.	492/492	481/481	374/374			



421 V2 (doble cuerpo)

	alto	ancho	fondo	kg	litros	Ref.
Ext.*	1510	642	482	420	88/123	13239
Int.	492/687	481/481	374/374			



422 V2 (doble cuerpo)

	alto	ancho	fondo	kg	litros	Ref.
Ext.*	1705	642	482	480	123/123	13240
Int.	687/687	481/481	374/374			

*en las medidas exteriores está incluida la peana

Caja electrónica con apertura y cierre automático con bulones motorizados.
Cuerpo construido con doble chapa de acero de 2 mm relleno de mortero y sistema antirradial
Puerta enrasada de 10 mm de espesor
Sistema de anclaje al suelo

Electronic motorised safes with automatic opening and closing system
Body with double 2 mm steel plate filled of concrete and anti-radial saw system
Door of 10 mm thickness
Anchorage system to the floor

Cofre forte electrónico com abertura e trancamento automático por trincos
Corpo fabricado com dupla chapa de aço de 2 mm de espessura, enchimento de cimento e sistema anti-radial porta de 10 mm de espessura
Cofre forte para embutir no solo



redBox 3 ES

con LUZ INTERIOR

Electrónicas
Electronic system
Eletrônica



Apertura con llave
Key opening



6 mm
Chapa de acero
Door Thickness



Apertura electrónica
Electronic opening



2 mm
Chapa de acero
Body Thickness

S.O.S.

Apertura de emergencia
Emergency opening



Cierre con bulones
Locking bolts

RB 2ES 2 bulones / Bolts
RB 3ES 3 bulones / Bolts
RB 4ES 3 bulones / Bolts

redbox

SOBREPONER

113

FREE STANDING SAFES / COFRES SUPERFICIE

RED BOX 2 ES

	alto	ancho	fondo	kg	litros	Ref.
Ext.	323	422	354	21	41	44012
Int.	319	418	310			

RED BOX 3 ES

	alto	ancho	fondo	kg	litros	Ref.
Ext.	432	537	350	30	70	44013
Int.	428	533	306			

RED BOX 4 ES

	alto	ancho	fondo	kg	litros	Ref.
Ext.	538	432	350	34	69	44014
Int.	534	428	305			

Provista de serie con cuatro orificios en la base y tres en el fondo para su fijación al suelo y pared respectivamente
Supplied with four holes in the base to be fixed to the floor and three holes at the bottom to be fixed to the wall
Fornecida de série com quatro orifícios na base e três no fundo para a sua fixação ao solo e parede respectivamente



ÉLITE MRE

Mecánicas y electrónicas
Key & Mechanical combinatio
and electronic system
Chave e combinação e eletrônica

CUERPO SUPERIOR

Apertura con llave
Key opening

Cierre con bulones
Locking bolts
2 bulones / Bolts

PUERTA 6 mm
Chapa de acero
Door Thickness

CUERPO 2 mm
Chapa de acero
Body Thickness

Receptora
Slot

CUERPO INFERIOR

Apertura con llave
Key opening
ÉLITE MRLL
ÉLITE MRM

Apertura electrónica
Electronic opening
ÉLITE MREP
ÉLITE MRE

Apertura con pomo
Key opening
ÉLITE MREP

Secreto
Mechanical combination
ÉLITE MRM

Cierre con bulones
Locking bolts
2 bulones / Bolts

PUERTA 40 mm
Chapa de acero
Door Thickness

CUERPO 40 mm
Chapa de acero
Body Thickness

ÉLITE MIXTA receptora

SOBREPONER

FREE STANDING SAFES / COFRES SUPERFICIE



ÉLITE MRLL			cuerpo superior			
	alto	ancho	fondo	kg	litros	Ref.
Ext.	290	370	305	17	25	14013
Int.	286	366	240			

			cuerpo inferior		
	alto	ancho	fondo	kg	litros
Ext.	304	391	306	84	12
Int.	220	305	182	(peso total 101 kg)	



ÉLITE MRM			cuerpo superior			
	alto	ancho	fondo	kg	litros	Ref.
Ext.	290	370	305	17	25	14014
Int.	286	366	240			

			cuerpo inferior		
	alto	ancho	fondo	kg	litros
Ext.	304	391	306	84	12
Int.	220	305	182	(peso total 101 kg)	



ÉLITE MREP			cuerpo superior			
	alto	ancho	fondo	kg	litros	Ref.
Ext.	290	370	305	17	25	14015
Int.	286	366	240			

			cuerpo inferior		
	alto	ancho	fondo	kg	litros
Ext.	304	391	306	84	12
Int.	220	305	182	(peso total 101 kg)	



ÉLITE MRE			cuerpo superior			
	alto	ancho	fondo	kg	litros	Ref.
Ext.	290	370	305	17	25	14017
Int.	286	366	240			

			cuerpo inferior		
	alto	ancho	fondo	kg	litros
Ext.	304	391	306	84	12
Int.	220	305	182	(peso total 101 kg)	

Provista de serie con cuatro orificios en la base y tres en el fondo para su fijación al suelo y pared respectivamente
Supplied with four holes in the base to be fixed to the floor and three holes at the bottom to be fixed to the wall
Fornecida de série com quatro orificios na base e três no fundo para a sua fixação ao solo e parede respectivamente



fac-HT motorizada

SOBREPONER

FREE STANDING SAFES / COFRES SUPERFICIE

Cierre con bulones
Locking bolts
2 bulones / Bolts

Apertura electrónica
Electronic opening

S.O.S. Apertura de emergencia
Emergency opening

PUERTA 6 mm
Chapa de acero
Door Thickness

CUERPO 2 mm
Chapa de acero
Body Thickness

- apertura motorizada
- código máster de apertura
- llave de apertura de emergencia
- acero cortado al láser de 3 mm de espesor
- indicador de batería baja
- kit y orificios de anclaje
- luz interior

FAC - HT						
	alto	ancho	fondo	kg	litros	Ref.
Ext.	195	400	410	14,4	28	38500
Int.	191	396	370			

unidad apertura computerizada

Ref.
38501

disponible lector de auditorías de eventos



cajas fuertes decorativas

DECORATIVE STRONG SAFES · COFRES FORTES DECORATIVOS

FAC



ÉPOCA 1931

DECORATIVA



1931 LL



Época 1931

	alto	ancho	fondo	kg	litros	Ref.
Ext.	915	500	415	150	54/30	18030 granate 18031 verde
Int.	500	380	285	superior		
Int.	230	370	355	inferior		

Época 1931 LL

	alto	ancho	fondo	kg	litros	Ref.
Ext.	915	500	415	150	54/30	18032 granate 18033 verde
Int.	500	380	285	superior		
Int.	230	370	355	inferior		



Apertura con llave
Key opening
1931 LL



Apertura electrónica
Electronic opening
1931



Sistema de apertura
con mando
Telecommand opening
1931

S.O.S.

Apertura de emergencia
Emergency opening

integral

Sistema de cierre integral
Locking system no bolts



8 mm
Chapa de acero
Door Thickness



2+2 mm
Chapa de acero
Body Thickness

Control remoto
Cajón inferior para DIN A4
Remote control
Lower drawer for DIN A4 size
Controlo remoto
Compartimento interior para
documentos de dimensão A4

1812 LIBRERÍA BURÓ

DECORATIVA

117



Buró 1812

Mueble exterior de chapa de acero de 2 mm de espesor
Envolvente de madera de pino
Bisagra horizontal para apertura basculante
Provista de serie con tres taladros en el fondo de la caja para su fijación a la pared

Steel plate external body (2 mm thickness)
Pine wood cover
Horizontal hinge for the pivot opening
Supplied with three drills in the bottom of the safe to be fixed to the wall

Móvel exterior em chapa de aço com 2 mm de espessura
Envolvente de madeira de pinho
Dobradiça horizontal para abertura basculante
Fornecida de série com três orifícios no fundo do cofre para a sua fixação à parede



Apertura con llave
Key opening



Cierre con bulones
Locking bolts
4 bulones / Bolts



6 mm
Chapa de acero
Door Thickness



2 mm
Chapa de acero
Body Thickness



Buró 1812

	alto	ancho	fondo	kg	litros	Ref.
Ext.	620	490	360	38	30	18021
Int.	250	415	290			

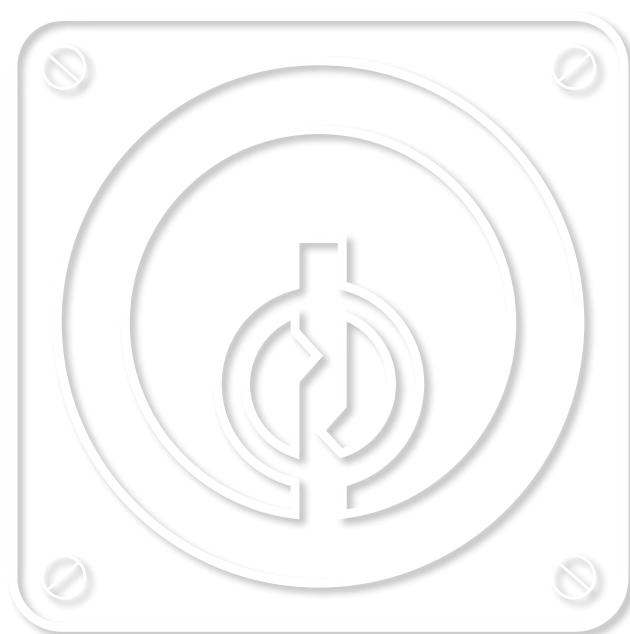



cajas fuertes profesionales

PROFESSIONAL STRONG SAFES · COFRES FORTES PROFESSIONAIS

FAC

FAC Seguridad, S.A.,
 con una presencia actual en 25 países
 y tras más de 80 años dedicada a la
 Seguridad Física (50 de los cuales
 construyendo Cajas Fuertes), le ofrece
 a través de su División de Proyectos
 Profesionales, la más completa gama de
 soluciones en los siguientes campos:

- Cajas Fuertes Homologadas
 (Soluciones Normalizadas)
- Proyectos y Soluciones Especiales tales
 como
- Cámaras Acorazadas mediante paneles
 prefabricados y/o sistema modular
 BLINDAFAC
- Protección contra el fuego, Cajas y
 Armarios Ignífugos y/o resistentes al
 fuego para papel o soporte magnético
- Integración de Cajas Fuertes en
 sistemas domóticos

NUEVO



LLAVE Y POMO

PUERTA 47,5 mm
 Acero y
 Mortero de alta resistencia
 Door Thickness

CUERPO 47,5 mm
 Acero y
 Mortero de alta resistencia
 Body Thickness

ARMERO ÉLITE-S

**CERTIFICADO EN GRADO III
 UNE EN 1143-1:2019 (AENOR)**



2 armas

ARMERO ÉLITE SM-7-LL

	alto	ancho	fondo	kg	litros	Ref.
Ext.	310	365	260	78	7	14300
Int.	222	275	117			



3 armas

ARMERO ÉLITE SM-12-LL

	alto	ancho	fondo	kg	litros	Ref.
Ext.	312	425	300	97	11.7	14310
Int.	222	335	157			



5 armas

ARMERO ÉLITE SM-19-LL

	alto	ancho	fondo	kg	litros	Ref.
Ext.	350	465	340	120	19	14320
Int.	260	365	197			

PARA LA CUSTODIA DE ARMA CORTA

Disponibles las opciones:
 Cerradura electrónica + pomo
 Cerradura electrónica + llave



target 502 - 16

Mecánicas sólo llave

Key only
Com chave



Apertura con llave
Key opening
100-4 / 102-110



Cierre con bulones
Locking bolts

100 - 4 4 bulones / Bolts
102 - 10 4 bulones / Bolts
502 - 16 5 bulones / Bolts



Volante
Wheel
502-16



3 mm
Chapa de acero
Door Thickness



3 mm
Chapa de acero
Body Thickness



target 100 - 4 armas

	alto	ancho	fondo	kg	litros	Ref.
Ext.	1400	280	240	51	71	14130
Int.	1394	270	187			

121



target 102 - 10 armas

	alto	ancho	fondo	kg	litros	Ref.
Ext.	1460	430	350	98	210	14132
Int.	1454	424	297			



target 502 - 16 armas

	alto	ancho	fondo	kg	litros	Ref.
Ext.	1460	730	350	130	307	14134
Int.	1454	724	292			

GREDOS

ARMERO GRADO I



gredos 100 - 4

CERTIFICADO EN ESPAÑA EN GRADO I UNE/EN 1143-1 2012
ACEPTADO POR TODAS LAS INTERVENCIONES DE ARMAS Y
EXPLOSIVOS DE LA GUARDIA CIVIL



gredos 100 - 7

Mecánicas sólo llave

Key only

Com chave



Apertura con llave
Key opening



Cierre con bulones
Locking bolts

100 - 4 6 bulones / Bolts
100 - 7 6 bulones / Bolts



3 + 10 + 1,5 mm
Chapa de acero y material aislante
Door Thickness



1,5 + 10 + 1,5 mm
Chapa de acero y material aislante
Body Thickness



gredos 100 - 4 armas G I

	alto	ancho	fondo	kg	litros	Ref.
Ext.	1400	280	240	82	59	14120
Int.	1373	253	170			



gredos 100 - 7 armas G I

	alto	ancho	fondo	kg	litros	Ref.
Ext.	1400	430	350	120	155	14121
Int.	1373	403	280			

ÉLITE 12

GRADO III



élite 12

HOMOLOGADO
UNE-EN 1143-1 2010
GRADO III

Cuerpo y puerta construidos con tubos rectangulares de acero de 2 mm de espesor
Relleno con mortero de alta resistencia
Refuerzo de chapa de acero para protección antitaladro de cerradura y bulones
Cerradura certificada Clase 2 VDS
Clase B ENV 1300

Body and door built with steel square pipes
Pipes filled with high resistance concrete
Lock and bolt protected by manganese steel plate
Attested lock
Type 2 VDS
Type B ENV 1300

Corpo e porta fabricados com tubos retangulares de aço
Enchimento da estrutura com argamasa de resistência
Reforço de chapa de aço para a proteção de trincos e fechadura
Fechadura registrada
Tipo 2 VDS
Tipo B ENV 1300

 Apertura con llave
Key opening
ÉLITE 12
ÉLITE 12 2LL
ÉLITE 12 M
ÉLITE 12 E

 Secreto
Mechanical combination
ÉLITE 12 M

 Apertura electrónica
Electronic opening
ÉLITE 12 E / ÉLITE 12 EP

 Apertura con pomo
Key opening
ÉLITE 12 EP

 Cierre con bulones
Locking bolts
2 bulones / Bolts

 40 mm
Chapa de acero
Door Thickness

 40 mm
Chapa de acero
Body Thickness



élite 12						
	alto	ancho	fondo	kg	litros	Ref.
Ext.	304	391	306	84	12	14009
Int.	220	305	182			



élite 12 2LL doble cierre						
	alto	ancho	fondo	kg	litros	Ref.
Ext.	304	391	306	84	12	14010
Int.	220	305	182			



élite 12 M						
	alto	ancho	fondo	kg	litros	Ref.
Ext.	304	391	306	84	12	14011
Int.	220	305	182			



élite 12 E						
	alto	ancho	fondo	kg	litros	Ref.
Ext.	304	391	306	84	12	14012
Int.	220	305	182			



élite 12 EP						
	alto	ancho	fondo	kg	litros	Ref.
Ext.	304	391	306	84	12	14016
Int.	220	305	182			

ÉLITE 21

GRADO III



élite 21

**HOMOLOGADO
UNE-EN 1143-1 2010
GRADO III**

Cuerpo y puerta contruidos con tubos rectangulares de acero de 2 mm de espesor
Relleno con mortero de alta resistencia
Refuerzo de chapa de acero para protección antitaladro de cerradura y bulones
Cerradura certificada Clase 2 VDS
Clase B ENV 1300

Body and door built with steel square pipes
Pipes filled with high resistance concrete
Lock and bolt protected by manganese steel plate
Attested lock
Type 2 VDS
Type B ENV 1300

Corpo e porta fabricados com tubos retangulares de aço
Enchimento da estrutura com argamasa de resistência
Reforço de chapa de aço para a proteção de trincos e fechadura
Fechadura registrada
Tipo 2 VDS
Tipo B ENV 1300



Apertura con llave
Key opening
ÉLITE 21
ÉLITE 21 2LL
ÉLITE 21 M
ÉLITE 21 E



Secreto
Mechanical combination
ÉLITE 21 M



Apertura electrónica
Electronic opening
ÉLITE 21 E
ÉLITE 21 EP



Apertura con pomo
Key opening
ÉLITE 21 EP



Cierre con bulones
Locking bolts
2 bulones / Bolts



40 mm
Chapa de acero
Door Thickness



40 mm
Chapa de acero
Body Thickness



élite 21

	alto	ancho	fondo	kg	litros	Ref.
Ext.	395	395	365	105	21	14109
Int.	310	310	220			



élite 21 2LL

doble cierre

	alto	ancho	fondo	kg	litros	Ref.
Ext.	395	395	365	105	21	14110
Int.	310	310	220			



élite 21 M

	alto	ancho	fondo	kg	litros	Ref.
Ext.	395	395	365	105	21	14111
Int.	310	310	220			



élite 21 E

	alto	ancho	fondo	kg	litros	Ref.
Ext.	395	395	365	105	21	14112
Int.	310	310	220			



élite 21 EP

	alto	ancho	fondo	kg	litros	Ref.
Ext.	395	395	365	105	21	14116
Int.	310	310	220			

SISTEMA CONSTRUCTIVO EQUIVALENTE A GRADO I UNE EN 1143



alfa 63

alfa 63 1LL						
	alto	ancho	fondo	kg	litros	Ref.
Ext.	550	530	445	175	65	33121

alfa 103 1LL						
	alto	ancho	fondo	kg	litros	Ref.
Ext.	690	550	500	221	102	33122

alfa 203 1LL						
	alto	ancho	fondo	kg	litros	Ref.
Ext.	1000	600	570	377	203	33123

alfa 273 1LL						
	alto	ancho	fondo	kg	litros	Ref.
Ext.	1330	600	570	418	276	33124

alfa 353 1LL						
	alto	ancho	fondo	kg	litros	Ref.
Ext.	1430	650	610	480	358	33125

alfa 63 2LL						
	alto	ancho	fondo	kg	litros	Ref.
Ext.	550	530	445	175	65	33131

alfa 103 2LL						
	alto	ancho	fondo	kg	litros	Ref.
Ext.	690	550	500	221	102	33132

alfa 203 2LL						
	alto	ancho	fondo	kg	litros	Ref.
Ext.	1000	600	570	377	203	33133

alfa 273 2LL						
	alto	ancho	fondo	kg	litros	Ref.
Ext.	1330	600	570	418	276	33134

alfa 353 2LL						
	alto	ancho	fondo	kg	litros	Ref.
Ext.	1430	650	610	480	358	33135

alfa 63 LLAVE+COMB.MEC						
	alto	ancho	fondo	kg	litros	Ref.
Ext.	550	530	445	175	65	33141

alfa 103 LLAVE+COMB.MEC						
	alto	ancho	fondo	kg	litros	Ref.
Ext.	690	550	500	221	102	33142

alfa 203 LLAVE+COMB.MEC						
	alto	ancho	fondo	kg	litros	Ref.
Ext.	1000	600	570	377	203	33143

alfa 273 LLAVE+COMB.MEC						
	alto	ancho	fondo	kg	litros	Ref.
Ext.	1330	600	570	418	276	33144

alfa 353 LLAVE+COMB.MEC						
	alto	ancho	fondo	kg	litros	Ref.
Ext.	1430	650	610	480	358	33145

alfa 63 LLAVE+COMB.ELEC (retardo)						
	alto	ancho	fondo	kg	litros	Ref.
Ext.	550	530	445	175	65	33151

alfa 103 LLAVE+COMB.ELEC (retardo)						
	alto	ancho	fondo	kg	litros	Ref.
Ext.	690	550	500	221	102	33152

alfa 203 LLAVE+COMB.ELEC (retardo)						
	alto	ancho	fondo	kg	litros	Ref.
Ext.	1000	600	570	377	203	33153

alfa 273 LLAVE+COMB.ELEC (retardo)						
	alto	ancho	fondo	kg	litros	Ref.
Ext.	1330	600	570	418	276	33154

alfa 353 LLAVE+COMB.ELEC (retardo)						
	alto	ancho	fondo	kg	litros	Ref.
Ext.	1430	650	610	480	358	33155

alfa 63 LL+COMB.ELEC (ret+bloqueo)						
	alto	ancho	fondo	kg	litros	Ref.
Ext.	550	530	445	175	65	33161

alfa 103 LL+COMB.ELEC (ret+bloqueo)						
	alto	ancho	fondo	kg	litros	Ref.
Ext.	690	550	500	221	102	33162

alfa 203 LL+COMB.ELEC (ret+bloqueo)						
	alto	ancho	fondo	kg	litros	Ref.
Ext.	1000	600	570	377	203	33163

alfa 273 LL+COMB.ELEC (ret+bloqueo)						
	alto	ancho	fondo	kg	litros	Ref.
Ext.	1330	600	570	418	276	33164

alfa 353 LL+COMB.ELEC (ret+bloqueo)						
	alto	ancho	fondo	kg	litros	Ref.
Ext.	1430	650	610	480	358	33165

 Apertura con llave
Key opening

 Secreto
Mechanical combination
OPCIONAL
OPTIONAL

 Apertura electrónica
Electronic opening
OPCIONAL
OPTIONAL

 Maneta
Handle

 Cierre con bulones
Locking bolts

Retardo y Retardo/Bloqueo
OPCIONAL

SUBMOSTRADOR SMD 1C

SOBREPONER

Pasa cable
→



Apertura con llave
Key opening



Apertura electrónica
Electronic opening



Cierre con bulones
Locking bolts
SMD 1C 2 bulones / Bolts



3+1 mm
Chapa de acero
Door Thickness



3 mm
Chapa de acero
Body Thickness

SMD 1C

Bulones sistema giratorio anti-sierra



SMD 1C

	alto	ancho	fondo	kg	litros	Ref.
Ext.	540	450	550	60	20/90	43001
Int.	160	342	467	cajón superior		
Int.	380	451	520	receptáculo inferior		

156 ESB

SOBREPONER



Apertura con llave
Key opening



Apertura electrónica
Electronic opening



Volante
Wheel



Receptora
Slot



Cierre con bulones
Locking bolts
8 bulones / Bolts



10 mm
Chapa de acero
Door Thickness



2+2 mm
Chapa de acero
Body Thickness



156 ESB

* Opcionalmente variación en altura



156 ESB



	alto	ancho	fondo	kg	litros	Ref.
Ext.	590	530	500	185	90	36820
Int.	469	462	419			

ARMARIO CASILLERO



30 - C



AR-C 25

- acero de 2 mm
- orificios para anclaje en pared
- formato: columnas y filas personalizables
- pintura epoxy personalizable en colores
- elección del cierre:
 - bombillo con llave o candado
 - cerradura de combinación con llave maestra



modular AC



AR-C 32						
	alto	ancho	fondo	kg	litros	Ref.
Ext.	850	1127	385	97,5	38	41300
Int.	330	330	350	casillero		

AR-C 15						
	alto	ancho	fondo	kg	litros	Ref.
Ext.	1900	368	385	61	38	41301
Int.	330	330	350	casillero		

AR-C 25						
	alto	ancho	fondo	kg	litros	Ref.
Ext.	1900	758	385	108	38	41302
Int.	330	330	350	casillero		

AR-C 35						
	alto	ancho	fondo	kg	litros	Ref.
Ext.	1900	1127	385	198	38	41303
Int.	330	330	350	casillero		

30-C						
	alto	ancho	fondo	kg	litros	Ref.
Ext.	770	1550	260	112	7	41310
Int.	105	285	235	casillero		

apilable modular AC						
	alto	ancho	fondo	kg	litros	Ref.
Ext.	160	240	300	6,5	10,5	41320
Int.	156	236	286	casillero	casillero	

PETRA

GRADO IV



PRODUCTO CERTIFICADO
GRADO IV
UNE EN 1143:2012



Pastilla homologada para anclaje de cajas fuertes y cajeros automáticos

Homologada resistencia al anclaje de más de 2.000 kilogramos conforme **UNE 108136 y O.M. 317/2011**

PASTILLA DE ANCLAJE CAJA PETRA F-45

mm	kg	Ref.
25	13	33591
50	24	

PASTILLA DE ANCLAJE CAJA PETRA F-60

mm	kg	Ref.
25	14	33592
50	29	

PASTILLA DE ANCLAJE CAJA PETRA F-100

mm	kg	Ref.
25	19	33593
50	40	

PASTILLA DE ANCLAJE CAJA PETRA F-150

mm	kg	Ref.
25	22	33594
50	49	

PASTILLA DE ANCLAJE CAJA PETRA F-200

mm	kg	Ref.
25	22	33595
50	49	

PASTILLA DE ANCLAJE CAJA PETRA F-270

mm	kg	Ref.
25	22	33596
50	49	

PASTILLA DE ANCLAJE CAJA PETRA F-350

mm	kg	Ref.
25	26	33597
50	57	

PASTILLA DE ANCLAJE CAJA PETRA F-450

mm	kg	Ref.
25	31	33598
50	70	

PASTILLA DE ANCLAJE CAJA PETRA F-540

mm	kg	Ref.
25	33	33599
50	75	



Apertura con llave
Key opening



Apertura electrónica
Electronic opening
OPCIONAL
OPTIONAL



Bandejas
Trays

F-45, F-60, F-100, F-150, F-200 2 bandejas/trays
F-270, F-350, F-450 3 bandejas/trays
F-540 4 bandejas/trays



Volante
Wheel



Maneta
Handle



Cierre con bulones
Locking bolts



Receptora
Slot

F-45, F-60, F-100 8 bulones/bolts
F-150, F-200, F-270, F-350, F-450, F-540 10 bulones/bolts

FAC ha desarrollado una completa gama de Cajas Fuertes para cubrir todas las necesidades existentes en el mercado.

Las Cajas Fuertes PETRA están diseñadas bajo las mayores exigencias de seguridad, que confieren una reducción de peso frente a las Cajas Fuertes tradicionales, incrementando el número de barreras y defensas en su estructura, para garantizar el nivel de seguridad requerido.

Características Generales

- Cierre mediante pestillos laterales, superior e inferior, comandados por expansivo multipunto y bloqueado por dos cerraduras y sistema de rebloqueo en caso de ataque a las mismas.
- Bisagras regulables en altura con casquillos auto-lubricantes que permiten la apertura de la hoja 180°.
- La Caja Fuerte está dotada de orificio para su anclaje a suelo. Los estantes son graduables en altura sobre cremalleras con efecto antivuelco.
- Acabado en base a doble capa de imprimación antioxidante y pintura epoxy texturada de gran resistencia.
- Homologada por Laboratorio Oficial Applus, según Norma Europea UNE EN 1143-1:2012
- Producto Certificado AENOR
- Marco de Puerta Reforzado con Protecciones Anti-cuña
- Pestillería comandada por Maneta, desplazando Pestillos cromados de Acero, lateral, superior e inferiormente, disponiendo en el lado de bisagras de Sistema Anti-Extracción y Anti-cuña.
- El bloqueo de la pestillería se consigue mediante la actuación, independiente, de dos cerraduras de llave y combinación con retardo incorporado, ambas clasificadas, Tipo B EN-1300, o Clase II VDS.



**PRODUCTO CERTIFICADO
GRADO IV
UNE EN 1143:2012**

petra F-45 2LL						
	alto	ancho	fondo	kg	litros	Ref.
Ext.	650	500	335	248	45	33501
Int.	570	420	190			

petra F-60 2LL						
	alto	ancho	fondo	kg	litros	Ref.
Ext.	650	500	400	269	61	33502
Int.	570	420	255			

petra F-100 2LL						
	alto	ancho	fondo	kg	litros	Ref.
Ext.	690	550	500	339	102	33503
Int.	610	470	355			

petra F-150 2LL						
	alto	ancho	fondo	kg	litros	Ref.
Ext.	780	600	570	425	155	33504
Int.	700	520	425			

petra F-200 2LL						
	alto	ancho	fondo	kg	litros	Ref.
Ext.	1000	600	570	520	203	33505
Int.	920	520	425			

petra F-270 2LL						
	alto	ancho	fondo	kg	litros	Ref.
Ext.	1330	600	570	661	276	33506
Int.	1250	520	425			

petra F-350 2LL						
	alto	ancho	fondo	kg	litros	Ref.
Ext.	1430	650	610	635	358	33507
Int.	1350	570	465			

petra F-450 2LL						
	alto	ancho	fondo	kg	litros	Ref.
Ext.	1430	700	700	641	465	33508
Int.	1350	620	555			

petra F-540 2LL						
	alto	ancho	fondo	kg	litros	Ref.
Ext.	1550	750	700	729	547	33509
Int.	1470	670	555			

petra F-45 LLAVE+COMB.MECÁNICA						
	alto	ancho	fondo	kg	litros	Ref.
Ext.	650	500	335	248	45	33511
Int.	570	420	190			

petra F-60 LLAVE+COMB.MECÁNICA						
	alto	ancho	fondo	kg	litros	Ref.
Ext.	650	500	400	269	61	33512
Int.	570	420	255			

petra F-100 LLAVE+COMB.MECÁNICA						
	alto	ancho	fondo	kg	litros	Ref.
Ext.	690	550	500	339	102	33513
Int.	610	470	355			

petra F-150 LLAVE+COMB.MECÁNICA						
	alto	ancho	fondo	kg	litros	Ref.
Ext.	780	600	570	425	155	33514
Int.	700	520	425			

petra F-200 LLAVE+COMB.MECÁNICA						
	alto	ancho	fondo	kg	litros	Ref.
Ext.	1000	600	570	520	203	33515
Int.	920	520	425			

petra F-270 LLAVE+COMB.MECÁNICA						
	alto	ancho	fondo	kg	litros	Ref.
Ext.	1330	600	570	661	276	33516
Int.	1250	520	425			

petra F-350 LLAVE+COMB.MECÁNICA						
	alto	ancho	fondo	kg	litros	Ref.
Ext.	1430	650	610	635	358	33517
Int.	1350	570	465			

petra F-450 LLAVE+COMB.MECÁNICA						
	alto	ancho	fondo	kg	litros	Ref.
Ext.	1430	700	700	641	465	33518
Int.	1350	620	555			

petra F-540 LLAVE+COMB.MECÁNICA						
	alto	ancho	fondo	kg	litros	Ref.
Ext.	1550	750	700	729	547	33519
Int.	1470	670	555			

petra F-45 LL+COMB.ELEC. RETARDO						
	alto	ancho	fondo	kg	litros	Ref.
Ext.	650	500	335	248	45	33521
Int.	570	420	190			

petra F-60 LL+COMB.ELEC. RETARDO						
	alto	ancho	fondo	kg	litros	Ref.
Ext.	650	500	400	269	61	33522
Int.	570	420	255			

petra F-100 LL+COMB.ELEC. RETARDO						
	alto	ancho	fondo	kg	litros	Ref.
Ext.	690	550	500	339	102	33523
Int.	610	470	355			

petra F-150 LL+COMB.ELEC. RETARDO						
	alto	ancho	fondo	kg	litros	Ref.
Ext.	780	600	570	425	155	33524
Int.	700	520	425			

petra F-200 LL+COMB.ELEC. RETARDO						
	alto	ancho	fondo	kg	litros	Ref.
Ext.	1000	600	570	520	203	33525
Int.	920	520	425			

petra F-270 LL+COMB.ELEC. RETARDO						
	alto	ancho	fondo	kg	litros	Ref.
Ext.	1330	600	570	661	276	33526
Int.	1250	520	425			

petra F-350 LL+COMB.ELEC. RETARDO						
	alto	ancho	fondo	kg	litros	Ref.
Ext.	1430	650	610	635	358	33527
Int.	1350	570	465			

petra F-450 LL+COMB.ELEC. RETARDO						
	alto	ancho	fondo	kg	litros	Ref.
Ext.	1430	700	700	641	465	33528
Int.	1350	620	555			

petra F-540 LL+COMB.ELEC. RETARDO						
	alto	ancho	fondo	kg	litros	Ref.
Ext.	1550	750	700	729	547	33529
Int.	1470	670	555			

petra F-45 LL+COMB.ELEC. RET+BLOQUEO						
	alto	ancho	fondo	kg	litros	Ref.
Ext.	650	500	335	248	45	33531
Int.	570	420	190			

petra F-60 LL+COMB.ELEC. RET+BLOQUEO						
	alto	ancho	fondo	kg	litros	Ref.
Ext.	650	500	400	269	61	33532
Int.	570	420	255			

petra F-100 LL+COMB.ELEC. RET+BLOQUEO						
	alto	ancho	fondo	kg	litros	Ref.
Ext.	690	550	500	339	102	33533
Int.	610	470	355			

petra F-150 LL+COMB.ELEC. RET+BLOQUEO						
	alto	ancho	fondo	kg	litros	Ref.
Ext.	780	600	570	425	155	33534
Int.	700	520	425			

petra F-200 LL+COMB.ELEC. RET+BLOQUEO						
	alto	ancho	fondo	kg	litros	Ref.
Ext.	1000	600	570	520	203	33535
Int.	920	520	425			

petra F-270 LL+COMB.ELEC. RET+BLOQUEO						
	alto	ancho	fondo	kg	litros	Ref.
Ext.	1330	600	570	661	276	33536
Int.	1250	520	425			

petra F-350 LL+COMB.ELEC. RET+BLOQUEO						
	alto	ancho	fondo	kg	litros	Ref.
Ext.	1430	650	610	635	358	33537
Int.	1350	570	465			

petra F-450 LL+COMB.ELEC. RET+BLOQUEO						
	alto	ancho	fondo	kg	litros	Ref.
Ext.	1430	700	700	641	465	33538
Int.	1350	620	555			

petra F-540 LL+COMB.ELEC. RET+BLOQUEO						
	alto	ancho	fondo	kg	litros	Ref.
Ext.	1550	750	700	729	547	33539
Int.	1470	670	555			

ARMARIO AR



AR 502-E



Apertura con llave
Key opening



Apertura electrónica
Electronic opening
AR 501 E / AR 502 E



Volante
Wheel



Cierre con bulones
Locking bolts

AR 501LL 5 bulones / Bolts
AR 502LL 5 bulones / Bolts
AR 501E 5 bulones / Bolts
AR 502E 5 bulones / Bolts



3 mm
Chapa de acero
Door Thickness



3 mm
Chapa de acero
Body Thickness



AR 501-LL

	alto	ancho	fondo	kg	litros	Ref.
Ext.	1460	500	350	98	209	41101
Int.	1454	494	291			



AR 502-LL

	alto	ancho	fondo	kg	litros	Ref.
Ext.	1460	730	350	130	307	41102
Int.	1454	724	292			



AR 501-E

	alto	ancho	fondo	kg	litros	Ref.
Ext.	1460	500	350	98	209	41111
Int.	1454	494	291			



AR 502-E

	alto	ancho	fondo	kg	litros	Ref.
Ext.	1460	730	350	130	307	41112
Int.	1454	724	292			

ARMARIOS REFORZADOS



AR 3100 - 25

Especialmente recomendado para empresas, colegios, hospitales, despachos, ejército, etc.

Construido en base a chapa de acero de 2 mm., con cerradura de alta seguridad clasificada VDS.

Cierre mediante pestillos laterales, superior e inferior, comandados por expansivo multipunto y bloqueado por cerradura.

Bisagras regulables en altura con casquillos auto-lubricantes que permiten la apertura de la hoja 180°.

Sistema antiextracción en lado bisagra.

Bandejas regulables en altura y efecto anti-vuelco.

Dispone de orificio para su anclaje al suelo.

El acabado final se consigue protegiendo todo el armario con imprimación antioxidante y pintura epoxy texturizada, Ral 7035

Accesorios opcionales:

Secreter interior con cerradura individual.

Cerradura combinación electrónica

armario reforzado 3100-25 SLL						
	alto	ancho	fondo	kg	litros	Ref.
Ext.	1000	600	500	114	249	33061
armario reforzado 3200-33 SLL						
	alto	ancho	fondo	kg	litros	Ref.
Ext.	1000	1000	500	145	416	33062
armario reforzado 3600-53 SLL						
	alto	ancho	fondo	kg	litros	Ref.
Ext.	1650	700	600	180	595	33063
armario reforzado 3700-66 SLL						
	alto	ancho	fondo	kg	litros	Ref.
Ext.	1950	1000	500	255	813	33064
armario reforzado 3100-25 SLL+comb.mecánica						
	alto	ancho	fondo	kg	litros	Ref.
Ext.	1000	600	500	114	249	33065
armario reforzado 3200-33 SLL+comb.mecánica						
	alto	ancho	fondo	kg	litros	Ref.
Ext.	1000	1000	500	180	595	33066

armario reforzado 3600-53 SLL+comb.mecánica						
	alto	ancho	fondo	kg	litros	Ref.
Ext.	1650	700	600	145	416	33067
armario reforzado 3700-66 SLL+comb.mecánica						
	alto	ancho	fondo	kg	litros	Ref.
Ext.	1950	1000	500	255	813	33068
armario reforzado 3100-25 SLL+comb.electrónica						
	alto	ancho	fondo	kg	litros	Ref.
Ext.	1000	600	500	114	249	33069
armario reforzado 3200-33 SLL+comb.electrónica						
	alto	ancho	fondo	kg	litros	Ref.
Ext.	1000	1000	500	180	595	33070
armario reforzado 3600-53 SLL+comb.electrónica						
	alto	ancho	fondo	kg	litros	Ref.
Ext.	1650	700	600	145	416	33071
armario reforzado 3700-66 SLL+comb.electrónica						
	alto	ancho	fondo	kg	litros	Ref.
Ext.	1950	1000	500	255	813	33072

Apertura con llave
Key opening

Secreto
Mechanical combination
OPCIONAL
OPTIONAL

Apertura electrónica
Electronic opening
OPCIONAL
OPTIONAL

Maneta
Handle

Cierre con bulones
Locking bolts
5 bulones / Bolts

Acabado puerta: RAL 7035
Acabado cuerpo: RAL 7035
Door finish: RAL 7035
Body finish: RAL 7035
Acabamento de porta: RAL 7035
Acabamento de corpo: RAL 7035

Accesorios opcionales:
Secreter interior con cerradura individual.
Cerradura combinación electrónica

Bandejas
Trays
3100-25, 3200-33 2 bandejas/trays
3600-53 3 bandejas/trays
3700-66 4 bandejas/trays

CAJA 117

SOBREPONER



caja 117-CE



caja 117-CE SC

SECRETER

La caja dispone en su interior de un compartimento auxiliar de depósito para la custodia de los valores depositados a través de la ranura del propio compartimento. El acceso al interior del secreter es restringido e independiente del resto de la caja por medio de 2 llaves.



Apertura electrónica
Electronic opening

Cerradura de alta seguridad certificado en Clase B, según norma UNE-ENE 1300, con las siguientes prestaciones:

- Códigos Máster, Manager, usuarios y usuarios de override (hasta 90 en total).
- Tiempo de retardo, tiempo de retardo variable, ventana de apertura.
- Caducidad de código programable.
- Bloqueo semanal, periodos de apertura y cierre, bloqueo inmediato y temporal.
- Memoria de eventos.
- Penalización por intentos erróneos.
- Test de sistema.

OTRAS OPCIONES DE CERRADURA ELECTRÓNICA DISPONIBLE. CONSULTAR.



Volante
Wheel



8 bulones / Bolts (2 + 4 + 2)

3 bulones / Bolts (en bisagra)



10 mm
Chapa de acero
Door Thickness



2+37+2 mm
2+70+2 mm (pared superior)
Chapa de acero y mortero
Body Thickness

Recogida final y custodia de cartuchos con efectivo, documentos o muestras de laboratorio, que llegan a la caja por medio del sistema de Transporte Neumático instalado o a instalar, adaptando en la parte superior del cajón un sistema de recepción para la tubería de PVC que forma parte del recorrido del sistema de transporte neumático y que dispone de un sistema anti-bloqueo y anti-pesca de los cartuchos transportados.

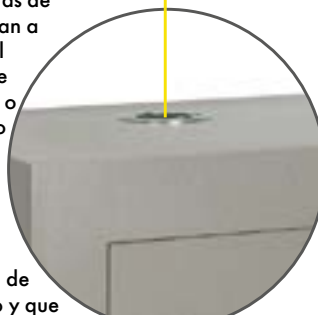

ANTI-BLOQUEO
ANTI-PESCA

ADAPTADOR DE TUBERÍA
TUBO DE ACERO



caja 117-CE TN

Salida de cables para conexión de alarma, la caja dispone de un tubo Ø15 con salida por la parte posterior del cajón.

Los componentes que forman la caja fuerte están pintados con pintura en polvo (Epoxi) de alta resistencia en cámara de niebla salina, RAL 7030.

caja 117-CE

	alto	ancho	fondo	kg	litros	Ref.
Ext.	803	566	462	220	124	36833
Int.	687	481	374			

caja 117-CE TN

	alto	ancho	fondo	kg	litros	Ref.
Ext.	803	566	462	220	124	36834
Int.	687	481	374			

caja 117-CE SC

	alto	ancho	fondo	kg	litros	Ref.
Ext.	803	566	462	235	70,5	36835
Int.	392	481	374			
SECRETER	290	481	288		40	

CAJAS DE DEPÓSITO RASHA

SOBREPONER



125 BB
con secreter interior



28 BBT



22 BB

Por su diseño y su fácil instalación, se pueden colocar en domicilios, negocios, oficinas, etc. Están dotadas de un buzón basculante en la parte superior para la introducción de sobres, dinero, documentos, objetos, etc., Sin tener que abrir la caja para depositarlos y una peana de 800 mm de altura para facilitar el depósito de objetos sin tener que agacharse.



Apertura electrónica
Electronic opening
OPCIONAL
OPTIONAL



Apertura con pomo
Key opening



Cierre con bulones
Locking bolts

22 B 6 bulones / bolts
28 BB 4 bulones / bolts
28 BBT 4 bulones / bolts
125 BB 8 bulones / bolts
125 BBT 8 bulones / bolts



Receptora
Slot



10 mm
Chapa de acero
Door Thickness



(22 B)
6 mm
Chapa de acero
Door Thickness



4 mm
Chapa de acero
Body Thickness



3 mm
Chapa de acero
Body Thickness



22 BB							✉
	alto	ancho	fondo	kg	litros	Ref.	
Ext.	600	280	250	26	22	43100	
Int.	400	274	200	32	con peana		

peana : 800 mm de altura



125 BB							✉
	alto	ancho	fondo	kg	litros	Ref.	
Ext.	1015	510	510	162	125	36034	
Int.	539	502	460				



125 BBT							✉
	alto	ancho	fondo	kg	litros	Ref.	
Ext.	1015	510	510	162	125	36038	
Int.	539	502	460				



28 BB							✉
	alto	ancho	fondo	kg	litros	Ref.	
Ext.	560	380	380	64	28	36037	
Int.	238	372	330				



28 BBT							✉
	alto	ancho	fondo	kg	litros	Ref.	
Ext.	560	380	380	64	28	36033	
Int.	238	372	330				

PUERTA BLINDAFAC

ACORAZADA MODULAR



Modular acorazada RS



Modular acorazada

Con estructura interior realizada en acero de gran espesor, van dotadas con blindajes especiales en toda la superficie de la puerta
 Armadura anti-palanca y anti-delaminación, rellena de hormigón
 Protecciones de acero al manganeso
 Perfil antipalanca en el lado de las bisagras
 Cerradura con llave de doble paletón VDS KL1
 Combinación mecánica con tres discos
 Combinación electrónica más llave de doble paletón VDS KL1. Opcional

Internal structure made of thick steel. They are equipped with special relocking devices on the whole surface of the door

Tear-resistant and levering-resistant shield, with concrete inside (except AD 1700)

Manganese steel protection of the mechanism

Continuous anti-wrench outline on the hinged side

Lock with double bit key VDS KL 1

Mechanical combination lock with three wheels

Optional electronic lock

Estrutura interna fabricada em aço de grande espessura, apresentando blindagens especiais em toda a superfície da porta.

Armadura antiarrombamento e anti-corte, preenchida com betão

Armadura anti-arrombamento e anti-corte, preenchida com betão (exceto mod. AD 1700)

Proteções de aço manganês

Perfil anti-arrombamento no lado das dobradiças

Fechadura com chave de duplo palhetão VDS KL1

Combinação mecânica com três discos

Fechadura eletrônica opcional



Apertura con llave
Key opening



Secreto
Mechanical combination
OPCIONAL
OPTIONAL



Apertura electrónica
Electronic opening
OPCIONAL
OPTIONAL



Volante
Wheel



Cierre con bulones
Locking bolts

Modular Acorazada 16 bulones / Bolts
Modular Acorazada RS 5 Pletinas



3+3 mm
Chapa de acero
Door Thickness



modular acorazada

	alto	ancho	acabado	kg	espesor	Ref.
Exterior	1860	750	RAL 7016	173	140	37101
Hueco puerta	1600	600	RAL 7001			



modular acorazada RS (Grado V)

	alto	ancho	acabado	kg	espesor	Ref.
Exterior	1860	750	RAL 7016	285	140	37100
Hueco puerta	1600	600	RAL 7001			

RECINTO BLINDAFAC

RECINTOS DE SEGURIDAD



14.2 Kg

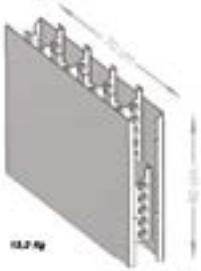

14.2 Kg

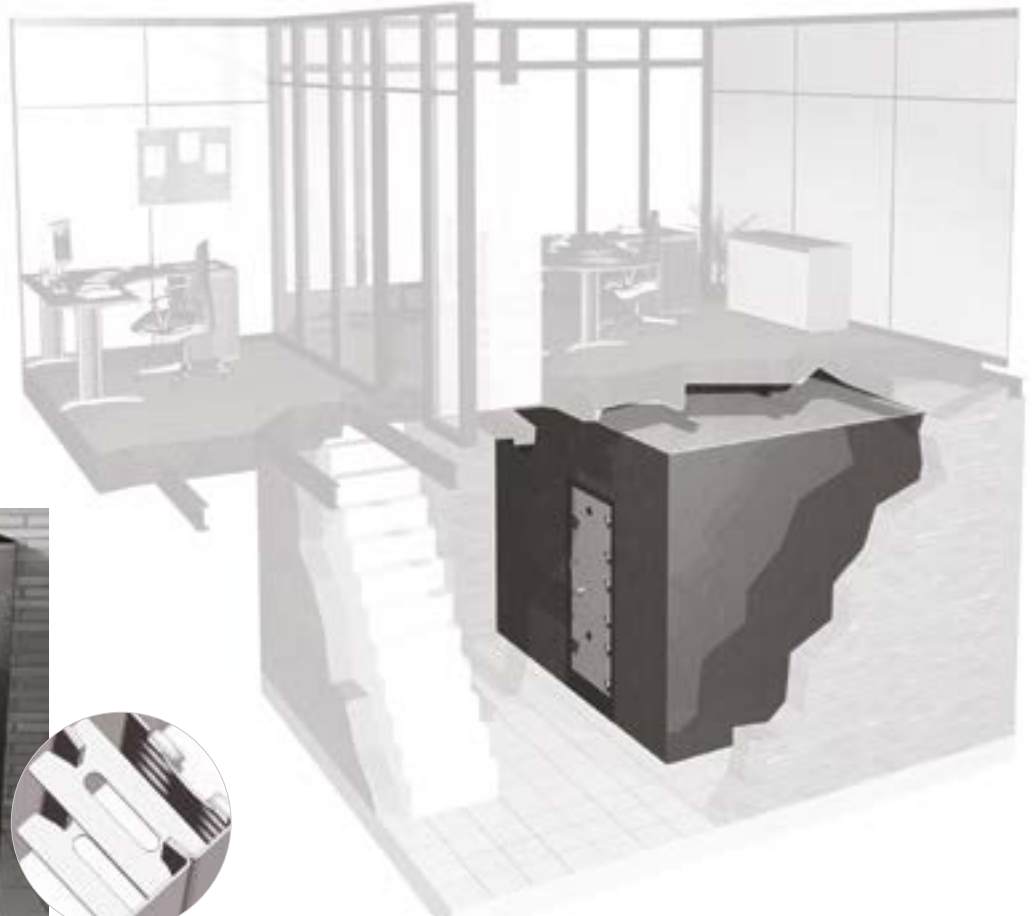

Detalle grapa de unión

DOMÉSTICO

Versión doméstica con alto grado de seguridad Compuesto por paneles de acero de fácil manejo Puerta monobloque dotada de tres cerraduras Mod. 480-B y dos pasadores interiores (visor opcional) Posibilidad de desmontaje para su traslado de ubicación

High security domestic version Made from easy manipulation panels Monoblock door provided with three locks Mod. 480-B and two internal bolts (optional window) Possible disassembling for the transfer to a different location

Versão doméstica com elevado grau de segurança Composto por painéis de aço de fácil manuseamento Porta monobloco dotada de três fechaduras Mod. 480-B e duas trancas interiores (visor opcional) Possibilidade de desmontagem para o seu local de instalação

Presupuesto personalizado

Budget according to customer's needs

Orçamento personalizado

PROFESIONAL

HOMOLOGADO UNE - EN 1143-1 GRADO V

Homologado con Grado V según la norma europea EN 1143-1 (también disponible sin homologación) Recintos acorazados modulares de rápida y sencilla instalación

Compuesto por bloques de acero de pequeñas dimensiones Construidos con materiales de alta calidad y resistencia Medidas ajustables

Puerta de diseño modular con dos cerraduras homologadas y un pasador interior que acciona la pletina de acero central Destinados a la protección de artículos de grandes dimensiones y a la protección de personas como cuarto antisecuestro

Grade V certificated, according to the European standard EN 1143-1 (also available without certification)

Modular strong rooms quick and easy to install

Made from small dimensions steel blocks

Formed from high quality and resistance materials

Adjustable dimensions

Modular strong door with two certificated locks and one internal handle which drives the central steel locking bar Both for the protection of goods and people like a panic room

Homologado com Grau V conforme a norma europeia EN 1143-1 (também disponível sem homologação)

Recintos blindados modulares de simples e rápida instalação

Composto por blocos de aço de pequenas dimensões

Fabricados com materiais de alta qualidade e resistência Medidas ajustáveis

Porta de design modular com duas fechaduras homologadas e uma tranca interior que acciona a barra de aço central Destinados à protecção de artigos de grandes dimensões e à protecção de pessoas como quarto anti-sequestro

NUEVO ANTI-OKUPAFAC



Puerta modular

Construcción modular.
Fácil transporte e instalación.
CÓMODO almacenaje después de su uso.
Doble cierre anti-bumping.

Puerta Modular				
	alto	ancho	kg	Ref.
Cerco	2070	920	76	41400
Puerta	1296	546		

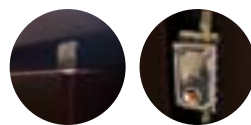

Puerta compacta

Robusta.
Instalación con y sin conservar puerta original.
Reversible (apertura a derecha o izquierda).
Tres puntos de cierre.

Puerta Compacta				
	alto	ancho	kg	Ref.
Puerta	2070	900	70	41401

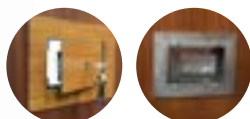

Conjunto cierre KAT DOOR

Ref. 41502

Efecto disuasorio.
Cerradura CERTIFICADA en clase B UNE EN 1300
Cierres internos imperceptibles.



2 cerrojos 946 UVE níquel + 1 bombillo igualados

KIT SEGURIDAD

Ref. 01232

Instalación fácil y definitiva.
Transporte convencional.
Comodidad de uso.
Efecto disuasorio.

Diseñado y fabricado en España



cajas ignífugas

FIREPROOF SAFES · COFRES ANTIFOGO

FAC

CAJAS INGNÍFUGAS

REQUISITOS PARA CADA CLASE DE PROTECCIÓN

S/Norma UNE EN 1047 equivalente a la norma NT FIRE 017

Clase de protección		Incremento de Temperatura máxima	Humedad relativa máxima
60 min.	120 min.		
60 P	120 P	150° C	No necesita
60 D	120 D	50° C	85 %
60 DIS	120 DIS	30° C	85 %

Los valores numéricos de las clases de protección son los tiempos de exposición al fuego durante los ensayos, en minutos, y las letras caracterizan los tipos de bancos que pueden ser protegidos en cada clase según:

P Documentos en soporte papel térmicamente sensible, pero excluyendo papeles de las calidades que pierdan información por debajo de los 170 °C

D Bancos de datos sensibles a la temperatura y a la humedad, tales como bancos de datos magnéticos y papel sensible térmicamente, pero excluyendo bancos que pierdan información por debajo de los 70 °C

DIS Bancos de datos sensibles a la temperatura y a la humedad tales como disquetes, pero excluyendo bancos de datos que pierdan información por debajo de los 50 °C

FR 21 P

PROTECCIÓN PAPEL



FR 21 P

Cajas ignífugas con Certificación Sueca 60P para la protección de documentos
 Resiste temperaturas de hasta 1015 °C durante 60 minutos
 Caja construida con material aislante
 Sistema de cierre electrónico

Antifire safes with Sweden Certification 60P for documents protection
 Support temperatures up to 1015 °C for 60 minutes
 Safe built with isolate material
 Electronic locking system

Cofre forte anti-fogo com Certificação Sueca 60P para proteção de documentos
 Resiste a temperaturas de até 1015 °C durante 60 minutos
 Cofre forte fabricado com material isolante
 Sistema de trancamento electrónico



Apertura con pomo
 Key opening



Apertura electrónica
 Electronic opening



Cierre con bulones
 Locking bolts



FR 21 P

	alto	ancho	fondo	kg	litros	Ref.
Ext.	344	424	388	37	25	22049 azul
Int.	245	325	260			22050 roja

FR 21 P 2 bulones / Bolts

FR P

PROTECCIÓN PAPEL



FR 26 P



FR 40 P



FR 123 P

Cajas ignífugas con Certificación Sueca 60P (FR 26P) y 120P (FR 40P) para la protección de documentos Resiste temperaturas de hasta 1015 °C durante 60 minutos (FR 26P) y 120 minutos (FR 40P) Caja construida con material aislante

Sistema de cierre electrónico

Antifire safes with Sweden Certification 60P (FR 26P) and 120P (FR 40P) for documents protection Support temperatures up to 1015 °C for 60 minutes (FR 26P) and 120 minutes (FR 40P) Safe built with isolate material Electronic locking system

Cofre forte anti-fogo com Certificação Sueca 60P (FR 26P) e 120P (FR 40P) para proteção de documentos Resiste a temperaturas de até 1015 °C durante 60 minutos (FR 26P) e 120 minutos (FR 40P) Cofre forte fabricado com material isolante

Sistema de trancamento electrónico



Apertura con llave
Key opening
FR 40 P / FR 123 P



Apertura electrónica
Electronic opening



Maneta
Handle
FR 40 P
FR 123 P



Volante
Wheel
FR 26 P



Cierre con bulones
Locking bolts

FR 26 P 2 bulones / Bolts
FR 40 P 4 bulones / Bolts
FR 123 P 5 bulones / Bolts



FR 26 P

	alto	ancho	fondo	kg	litros	Ref.
Ext.	424	344	444	41	25	22051
Int.	325	245	316			



FR 40 P

	alto	ancho	fondo	kg	litros	Ref.
Ext.	542	491	467	96	40	22052
Int.	389	338	304			



FR 123 P

	alto	ancho	fondo	kg	litros	Ref.
Ext.	992	585	507	200	123	22053
Int.	833	426	346			

FR D

PROTECCIÓN SOPORTE MAGNÉTICO



FR 8 D



FR 13 D





FRA 123 D

Caja ignífuga con certificación sueca 60D para la protección de datos
Resiste temperaturas de hasta 1000 °C durante 60 minutos
Caja construida con material aislante
Sistema de cierre electrónico
Ruedas desmontables
(FR 13D)

Antifire safes with sweden certification 60D for data protection
Support temperatures up to 1000 °C for 60 minutes
Safe built with isolate material
Electronic locking system
Removable wheels
(FR 13D)m

Cofre forte anti-fogo com certificação sueca 60D para proteção de dados
Resiste a temperaturas de até 1000 °C durante 60 minutos
Cofre forte fabricado com material isolante
Sistema de trancamento electrónico
Rodas desmontáveis
(FR 13D)o

 Apertura con pomo
Key opening
FR 8 D

 Apertura electrónica
Electronic opening

 Maneta
Handle
FR 13 D
FR 123 D

 Cierre con bulones
Locking bolts

FR 8 D 2 bulones / Bolts
FR 13 D 4 bulones / Bolts
FR 123 D 5 bulones / Bolts



FR 8 D						
	alto	ancho	fondo	kg	litros	Ref.
Ext.	520	410	445	73	9	22054
Int.	279	169	187			



FR 13 D						
	alto	ancho	fondo	kg	litros	Ref.
Ext.	629	479	467	116	13	22055
Int.	364	214	167			



FRA 123 D						
	alto	ancho	fondo	kg	litros	Ref.
Ext.	992	585	507	241	48	22057
Int.	728	315	210			

FRA 81

ARCHIVADOR PROTECCIÓN PAPEL



FRA 81

Archivador antifuego con
Certificación Sueca 90P para protección
de documentos
Resiste temperaturas de hasta 1050 °C
durante 90 minutos
Caja construida con material aislante
Cierre automático de una sola cerradura
de seguridad con posibilidad de cerrar
cada cajón independientemente

Antifire file cabinet with Sweden
Certification 90P for document
protection
Support temperatures up to 1050 °C for
90 minutes
Safe built with isolate material
Automatic locking system with security
key with separate closing of each
drawer

Arquivador anti-fogo com Certificação
Sueca 90P para proteção de
documentos
Resiste a temperaturas de até 1050 °C
durante 90 minutos
Cofre forte fabricado com material
isolante
Trancamento automático de uma
só fechadura de segurança com
possibilidade de fecho independente
de cada compartimento



Apertura con llave
Key opening



FRA 81						
	alto	ancho	fondo	kg	litros	Ref.
Ext.	766	520	680	141	60	22056
Int.	285	400	526			

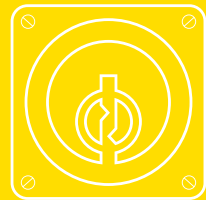

caudalitas
armarios portallaves
expositores
buzones

CASH BOXES, KEY BOXES,
STAND DISPLAYS, LETTER BOXES

COFRES PORTÁTILES, CHAVEIROS,
EXPOSITORES, CAIXAS DE CORREIO

FAC



(bandeja interior)

SÚPER

CAUDALITAS

CASH BOXES / COFRES PORTÁTILES

súper nº 2

alto	ancho	fondo	kg	litros	Ref.	
85	200	155	0,8	2,15	17020	blanco
					17021	rojo
					17022	azul
					17023	negro

súper nº 0

alto	ancho	fondo	kg	litros	Ref.	
70	130	100	0,4	0,65	17000	blanco
					17001	rojo
					17002	azul
					17003	negro

súper nº 3

alto	ancho	fondo	kg	litros	Ref.	
95	240	185	1,2	3,20	17030	blanco
					17031	rojo
					17032	azul
					17033	negro

súper nº 1

alto	ancho	fondo	kg	litros	Ref.	
75	155	120	0,6	1,30	17010	blanco
					17011	rojo
					17012	azul
					17013	negro

súper nº 4

alto	ancho	fondo	kg	litros	Ref.	
105	290	215	2	5,60	17040	blanco
					17041	rojo
					17042	azul
					17043	negro

COMBINACIÓN

CAUDALITAS

CASH BOXES / COFRES PORTÁTILES

combinación nº 2

alto	ancho	fondo	kg	litros	Ref.	
85	200	155	0,8	2,15	17044	azul
					17045	rojo

combinación nº 3

alto	ancho	fondo	kg	litros	Ref.	
95	240	185	1,2	3,20	17046	azul
					17047	rojo



(bandeja interior)



(bandeja interior)

INFANTILES

CAUDALITAS

CASH BOXES / COFRES PORTÁTILES

infantiles nº 0

alto	ancho	fondo	litros	Ref.	
60	125	95	0,50	17014	azul
				17015	rosa
				17016	verde
				17017	rojo
				17018	púrpura



(bandeja interior)

PULSADOR

CAUDALITAS
CASH BOXES / COFRES PORTÁTIES

pulsador nº 1					
alto	ancho	fondo	litros	Ref.	
85	165	125	0,90	25001	blanco
				25002	rojo
				25003	azul
				25004	gris

pulsador nº 3					
alto	ancho	fondo	litros	Ref.	
85	230	185	2,00	25009	blanco
				25010	rojo
				25011	azul
				25012	gris

pulsador nº 2					
alto	ancho	fondo	litros	Ref.	
85	197	154	1,5	25005	blanco
				25006	rojo
				25007	azul
				25008	gris

pulsador nº 4					
alto	ancho	fondo	litros	Ref.	
85	300	230	3,50	25013	blanco
				25014	rojo
				25015	azul
				25016	gris

EFFECTIVO

CAUDALITAS
CASH BOXES / COFRES PORTÁTIES

efectivo PRO M1						
alto	ancho	fondo	litros	Ref.		
90	300	230	6	17100	negro	



MÁQUINA CLASIFICADORA €

máq. clasificadora	
Ref.	
28001	

CAJA DE EMERGENCIA

EMERGENCY BOX / COFRE EMERGÈNCIA

caja de emergencia					
alto	ancho	fondo	llaves	Ref.	
170	170	50	1	26006	



ARMARIO PORTALLAVES

KEY BOXES / CHAVEIROS



portallaves K105

alto	ancho	fondo	llaves	Ref.
360	250	110	105	26004

portallaves K140

alto	ancho	fondo	llaves	Ref.
360	250	110	140	26005



portallaves K20

alto	ancho	fondo	llaves	Ref.
250	150	80	20	26001

portallaves K40

alto	ancho	fondo	llaves	Ref.
250	180	80	40	26002

portallaves K80

alto	ancho	fondo	llaves	Ref.
360	250	110	80	26003

GUARDALLAVES

KEY BOXES / CHAVEIROS

Guardallaves

	Ref.	Embalaje
Pintado	26100	blister

acero fundido

incluye tornillos

capacidad: 2 - 3 llaves

resistente a la intemperie

combinación de 4 dígitos programable



incluye 125 llaveros

125 soportes numerados

puerta y frontal de 6 mm
cortados por laser

luz interior
puerta desmontable

abertura lateral para depositar la llave
sin abrir la caja



Apertura electrónica
Electronic opening



Apertura con llave
Key opening
Apertura de emergencia
(doble llave)



6 mm
Chapa de acero
Door Thickness



2 mm
Chapa de acero
Body Thickness



4 bulones / Bolts

KEYBOX

CAJA FUERTE PARA LLAVES



KEY BOX 4SLL

	alto	ancho	fondo	kg	litros	Ref.
Ext.	538	432	350	34	70	05314
Int.	534	428	305			

KEY BOX 4ESLL

	alto	ancho	fondo	kg	litros	Ref.
Ext.	538	432	350	34	70	13314
Int.	534	428	305			

EXPOSITORES

expositores polivalentes
para cajas fuertes



para cajas de sobreponer
(necesario complemento
soportes)
Ref. 99029
Ref. 99088



para cajas de sobreponer
(necesario complemento
soportes)
Ref. 99088
Ref. 99030



para cajas de empotrar
Ref. 99088

expositor para
caudalitas

Ref. 99072



expositor para
caudalitas infantiles

Ref. 99071



expositor para
candados de arco

Ref. 99066



CANTÁBRICO

BUZONES

LETTER BOXES / CAIXAS DE CORREIO



Buzones construidos con chapa de acero de 1 mm de espesor
Acabado superficial en pintura epoxy
Cerradura con 2 llaves
Tornillería de fijación incluida
Disponibilidad de llaves en bruto

Letter boxes built with 1 mm thickness steel plate
High resistant epoxy powder
Lock with 2 keys
Fixing screws included
Blank keys available

Caixas de correio fabricados com chapa de aço de 1 mm de espessura
Acabamento superficial em pintura epoxy
Fechadura com 2 chaves
Parafusos para fixação incluida
Chaves originais disponivel

cantábrico			
alto	ancho	fondo	Ref.
320/320	260/240	120/100	30001 blanco
			30003 verde
			30004 granate

MEDITERRÁNEO

BUZONES

LETTER BOXES / CAIXAS DE CORREIO

mediterráneo			
alto	ancho	fondo	Ref.
350/350	290/240	120/100	30006 blanco
			30007 negro
			30008 verde
			30009 granate



Buzones construidos con chapa de acero de 1 mm de espesor
Acabado superficial en pintura epoxy
Cerradura con 2 llaves
Tornillería de fijación incluida
Disponibilidad de llaves en bruto

Letter boxes built with 1 mm thickness steel plate
High resistant epoxy powder
Lock with 2 keys
Fixing screws included
Blank keys available

Caixas de correio fabricados com chapa de aço de 1 mm de espessura
Acabamento superficial em pintura epoxy
Fechadura com 2 chaves
Parafusos para fixação incluida
Chaves originais disponivel



modelo patentado

ATLÁNTICO COMBI

BUZONES

LETTER BOXES / CAIXAS DE CORREIO

con receptor integrado de publicidad

atlántico combi			
alto	ancho	fondo	Ref.
360/360	391/240	120/100	30011 blanco
			30012 negro
			30013 verde
			30014 granate





especiales

SPECIAL ITEMS · ESPECIALES

FAC

ESPECIALES

BOMBILLOS SUELTOS PARA CERROJOS, CERRADURAS Y CONJUNTOS DE SEGURIDAD

llave dentada (F)		
	Tamaño	Ref.
304-F (pareja)	28	664010252000
304-DF (pareja)	28	664010253000
300-R	40	664010246000
U.E. (Unión Eléctrica)	40	664010256000
201-R	50	664010244000
301-R	50	664010248000
201-LS/101-L/S-90	50	664010245000
301-L	50	664010247000
201-R	70	664010274000
301-R	70	664010270000
201-L/101-L/S-90	70	664010275000
301-L	70	664010271000
U.E. (Unión Eléctrica)	70	664010268000
301-R	90	664010273000

llave de puntos (P)		
	Tamaño	Ref.
301-RP	50	664010249000
301-RP	70	664010267000
301-RP (dorado)	90	664010354040
301-RP (cromado)	90	664010354050
301-RP (dorado)	100	664010355040
301-RP (cromado)	100	664010355050
301-RP (dorado)	120	664010356040
301-RP (cromado)	120	664010356050
301-LP	50	664010258000
301-LP	70	664010266000
946-RP UVE/17 (dorado)	50	664010373040
946-RP UVE/17 (cromado)	50	664010373050
946-RP UVE/17 (dorado)	70	664010374040
946-RP UVE/17 (cromado)	70	664010374050
946-LP UVE/17 (dorado)	50	664010375040
946-LP UVE/17 (cromado)	50	664010375050
946-LP/S-90 P UVE (dorado)	70	664010376040
946-LP/S-90 P UVE (cromado)	70	664010376050
S-90 P UVE (dorado)	50	664010372040
S-90 P UVE (cromado)	50	664010372050
MB/MB86/MBA PL UVE (cr)	50	666010346000
MB/MB86/MBA P-pomo UVE (cr)	50	666010347000

BOMBILLOS HOMOLOGADOS PERFIL EUROPEO

cilindro llave dentada (F) U.E. leva 15 mm (3 llaves)

		Tamaño	Ref.
Cil. MC U.E. (Unión Eléctrica)	latón	30x10	07007
	latón	40x10	07534
	latón	50x10	07535
	latón	40x40	07540

cilindro pomo llave dentada (F) leva 15 mm (3 llaves)

		Tamaño	Ref.
Cil. Amaestrado UFG (Unión Fenosa Galicia)	latón	40x30	07008
	níquel	40x30	07020
	latón	50x30	07010
	níquel	50x30	07021
	latón	60x30	07019
Cil. Amaestrado AC (Aguas de La Coruña)	latón	40x30	07009
	latón	50x30	07011
Cil. Amaestrado CYII (Canal de Isabel II)	latón	40x30	07030
Cil. Amaestrado GCM (Gas Castilla La Mancha)	latón	40x30	07031
Cil. MC Hidroeléctrica	latón	40x30	07040

cilindro pomo llave dentada (F) leva 13,5 mm (3 llaves)

		Tamaño	Ref.
Cil. Amaestrado UFG (Unión Fenosa Galicia)	latón	40x30	07016
	níquel	40x30	07022
	latón	50x30	07017
	níquel	50x30	07023





CONJUNTO CERRADURAS

cerraduras MB 86

	Color	Ref.
MB 86 PL	pintado	606010581000
MB 86 PL	dorado	606010583000
MB 86 PP	pintado	606010587000
MB 86 PP	dorado	606010589000

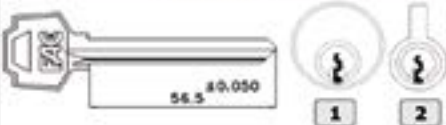
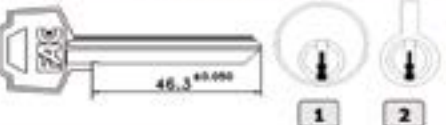
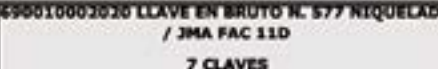
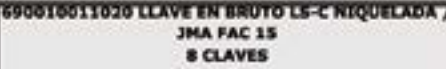
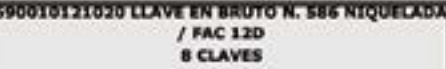
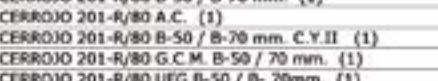
ESPECIALES

LLAVES SIN TALLAR

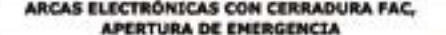
690010007020 LLAVE EN BRUTO N. 571 NIQUELADA / JMA FAC 10D 6 CLAVES	690010119020 LLAVE EN BRUTO L-70 NIQUELADA / FAC 14D 11 CLAVES 6+2+3	690010005020 LLAVE EN BRUTO LS NIQUELADA / JMA FAC 18 9 CLAVES 3+1+5
		
CERROJO 50-R/80 B-40 mm. BLISTER (2) CERROJO 300-R/80 (2) CERROJO EN PAREJA 304-F/130 (1) CERROJO 427-R/65 (2) CERROJO 428-R/65 (2) CERROJO 300-R/80 HIDROELECTRICA (2) CERROJO 300-R/80 A. CUENCA (2) CERROJO 300-R/80 B-70 mm. HIDROELECT. (2) CANDADO CIERRE GAS 3/4" (2) CANDADO CIERRE GAS 1" (2) CANDADO 506/80 - 506/50 (1) CANDADO 530/70 MOTO (2) CANDADO 530/150 MOTO (2) CANDADO 75/90 (2) CANDADO 75/140 (2) CAJA 100-MINI-LL (1) CAJA 100-MINI-M (1) CAJA 6570/T (1) CAJA 6570/C (1) CAJA 901-J (1) CAJA 102-SLD (1) ANTIRROBO 82 / 82 ANCHO (2) ANTIRROBO 83 CAR (2) ANTIR. 83 CAR AMARILLO (2) ANTIRROBO CAR 2002 (2) CILINDRO MC HIDROELEC. 40x30 (LEVA 15) ARMARIO CASILLERO MODULAR AC (2) CANDADO 530 METRO (2) ANTIRROBO CAR ROJO (2) CANDADO 530/200 (2)	CERRADURA SOB. S-90 A B-70 mm. (1) CERROJO 101-L/105 B-70 mm. (1) CERROJO 201-L/80 B-70 mm. (1) CERRADURA SOB. S-90 C B-70 mm. (1) CERRADURA SOB. S-90 B-70 mm. (1) CERROJO 303-L/115 B-70 mm. (2) CERROJO 302-L/115 B-70 mm. (2) CERROJO 301-L/120 B-70 mm. (2) CERROJO 301-L/80 B-70 mm. (2) CERROJO 307-L/80 B-70 mm. (2)	CERROJO 101-L/105 B-90 mm. (1) CERROJO 101-L/105 DELTA (1) CERROJO 201-L/80 (1) CERRADURA SOB. S-90 / S-90 C / S-90 A (1) CERROJO 101-L/105 BARRA PROX. 177 mm. (1) CERROJO 101-L/105 (1) CERROJO 306-L/115 (2) CERROJO 301 L/80 B - 90 mm. BOMBILLO 201-LS / 101-L / S-90 90 mm. FAC (1) BOMBILLO 201-LS / 101-L / S-90 FAC (1) BOMBILLO 306-L FAC (2)
690010002020 LLAVE EN BRUTO N. 577 NIQUELADA / JMA FAC 11D 7 CLAVES	690010044020 LLAVE EN BRUTO N. 587 NIQUELADA / JMA FAC 13D 8 CLAVES 4+1+3	690010020020 LLAVE EN BRUTO 91-C NIQUELADA / JMA FAC 20D 5 CLAVES
		
BOMBILLO 201-R B-50 / B-70 mm. FAC (1) BOMBILLO 301-R B-50 / B-70 / B-90 mm. FAC (2) BOMBILLO 302-303-T B-50 / B-70 / B-90 mm. FAC (2) CERROJO 101-R/105 GARAJE / 20 / 40 (1) CERROJO 101-R/105 B-50 / B-70 / B-90 mm. (1) CERROJO 101-R/105 DELTA (1) CERROJO 201-R/80 B-50 / B-70 mm. (1) CERROJO 201-R/80 A.C. (1) CERROJO 201-R/80 B-50 / B-70 mm. C.Y.II (1) CERROJO 201-R/80 G.C.M. B-50 / 70 mm. (1) CERROJO 201-R/80 UFG B-50 / B-70mm. (1) CERROJO 300-R/80 B-70 / B-90 mm. (2) CERROJO 301-R/120 B-50 / B-70 / B-90 mm. (2) CERROJO 301-R/80 B-50 / B-70 / B-90 mm. (2) CERROJO 301-R/80 B-50 / B-70 / B-90 mm. C/CAJA T (2) CERROJO 301-R/80 B-50 / B-70 / B-90 mm. C/CAJA T/2 GIP CERROJO 302-T/115 B-50 / B-70 / B-90 mm. (2) CERROJO 303-T/115 B-50 / B-70 / B-90 mm. (2) CERROJO 305-R/80 B-50 / B-70 / B-90 mm. (2) CERROJO 307-R/80 B-50 / B-70 / B-90 mm. (2) CERROJO 308-R/80 B-50 / B-70 / B-90 mm. (2) CERROJO 427-R/65 B-70 / B-90 mm. (2) CERROJO 428-R/65 B-70 / B-90 mm. (2) CERROJO 428-R/65 TECNOTRON (2) CERROJO EN PAREJA 301-R/80 (2) CERROJO N 1-T/230 (2) CERROJO N 1-T/230 B-70 mm. (2) CERROJO N 1-T/230 B-90 mm. (2) CILINDRO AMAESTRADO A.C. 40x30 (LEVA 15) CILINDRO AMAESTRADO A.C. 50x30 (LEVA 15) CILINDRO AMAESTRADO C.Y.II 40x30 (LEVA 15) CILINDRO AMAESTRADO GCM 40x30 (LEVA 15) CILINDRO AMAESTRADO UFG 40x30 (LEVA 13,5) CILINDRO AMAESTRADO UFG 40x30 (LEVA 15) CILINDRO AMAESTRADO UFG 50x30 (LEVA 13,5) CILINDRO AMAESTRADO UFG 50x30 (LEVA 15) CILINDRO AMAESTRADO UFG 60x30 (LEVA 15) CONJ. CILINDRO 201-R 90 mm. (1)	CERROJO 301-L/80 CERROJO 301-L/120 CERROJO 302-L/115 CERROJO 303-L/115 CERROJO 307-L/80 BOMBILLO 301-L FAC	CERROJO 91-C/80 CANDADO 507/50 CERROJO 50-R/80 TRASTERO CERROJO 50-R/80 CILINDRO SCHNEIDER MC 15460 CANDADO 507/40 -60
690010001020 LLAVE EN BRUTO LS-C NIQUELADA / JMA FAC 15 8 CLAVES	690000013000 LLAVE 558 / JMA FAC 5D 4 CLAVES	690010121020 LLAVE EN BRUTO N. 586 NIQUELADA / FAC 12D 8 CLAVES
		
BOMBILLO 201-R B-50 / B-70 mm. FAC (1) BOMBILLO 301-R B-50 / B-70 / B-90 mm. FAC (2) BOMBILLO 302-303-T B-50 / B-70 / B-90 mm. FAC (2) CERROJO 101-R/105 GARAJE / 20 / 40 (1) CERROJO 101-R/105 B-50 / B-70 / B-90 mm. (1) CERROJO 101-R/105 DELTA (1) CERROJO 201-R/80 B-50 / B-70 mm. (1) CERROJO 201-R/80 A.C. (1) CERROJO 201-R/80 B-50 / B-70 mm. C.Y.II (1) CERROJO 201-R/80 G.C.M. B-50 / 70 mm. (1) CERROJO 201-R/80 UFG B-50 / B-70mm. (1) CERROJO 300-R/80 B-70 / B-90 mm. (2) CERROJO 301-R/120 B-50 / B-70 / B-90 mm. (2) CERROJO 301-R/80 B-50 / B-70 / B-90 mm. (2) CERROJO 301-R/80 B-50 / B-70 / B-90 mm. C/CAJA T (2) CERROJO 301-R/80 B-50 / B-70 / B-90 mm. C/CAJA T/2 GIP CERROJO 302-T/115 B-50 / B-70 / B-90 mm. (2) CERROJO 303-T/115 B-50 / B-70 / B-90 mm. (2) CERROJO 305-R/80 B-50 / B-70 / B-90 mm. (2) CERROJO 307-R/80 B-50 / B-70 / B-90 mm. (2) CERROJO 308-R/80 B-50 / B-70 / B-90 mm. (2) CERROJO 427-R/65 B-70 / B-90 mm. (2) CERROJO 428-R/65 B-70 / B-90 mm. (2) CERROJO 428-R/65 TECNOTRON (2) CERROJO EN PAREJA 301-R/80 (2) CERROJO N 1-T/230 (2) CERROJO N 1-T/230 B-70 mm. (2) CERROJO N 1-T/230 B-90 mm. (2) CILINDRO AMAESTRADO A.C. 40x30 (LEVA 15) CILINDRO AMAESTRADO A.C. 50x30 (LEVA 15) CILINDRO AMAESTRADO C.Y.II 40x30 (LEVA 15) CILINDRO AMAESTRADO GCM 40x30 (LEVA 15) CILINDRO AMAESTRADO UFG 40x30 (LEVA 13,5) CILINDRO AMAESTRADO UFG 40x30 (LEVA 15) CILINDRO AMAESTRADO UFG 50x30 (LEVA 13,5) CILINDRO AMAESTRADO UFG 50x30 (LEVA 15) CILINDRO AMAESTRADO UFG 60x30 (LEVA 15) CONJ. CILINDRO 201-R 90 mm. (1)	CERROJO EN PAREJA 304-DF/130 NIQUEL BOMBILLO 304-DF (3-2) FAC BOMBILLO 304-DF (3-2) FAC	CERROJO 306-L/115 B-70 mm. BOMBILLO 306-L 70 m/m. FAC
692000061000/LLAVE ARCA ELECTRONICA POMO JMA 4G	690000049000 LLAVE EN BRUTO 589 JMA FAC 1G	690000058000 /LLAVE SIN GUIA NUMERO 1/2 JMA 3G
		
ARCAS ELECTRONICAS DE POMO CON CERRADURA FAC	ARCAS CON CERRADURA FAC MECANICAS ELECTRONICAS APERTURA NORMAL SERIE 2000 LLAVE	ARCAS ELECTRONICAS CON CERRADURA FAC, APERTURA DE EMERGENCIA

LLAVES SIN TALLAR

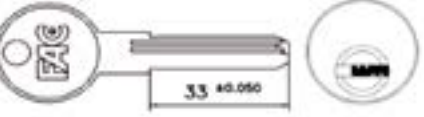
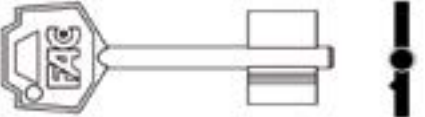
690000226000 LLAVE PLANA CUELLO LARGO / JMA FAC 25 6 CLAVES	690000226000 LLAVE PLANA CUELLO LARGO / JMA FAC 25 6 CLAVES	690010040020 LLAVE EN BRUTO N. 590 480-B NIQUELADA / JMA FAC 2G
		
BOMBILLO 301-LP FAC BOMBILLO 301-RP 70 m/m. FAC BOMBILLO 301-RP 90 m/m. FAC BOMBILLO 301-RP FAC BOMBILLO S-90 P 70 m/m. FAC BOMBILLO S-90 P FAC	CERRADURA SOB. MB PL CERRADURA SOB. MB-86 PL CERRADURA SOB. MBA PL	CAJA VIDEOGRABADOR 102 CV CERRADURA EMB. MAD. 480-B CERRADURA EMB. MAD. 480-B DOBLE AMAESTRADA
BOMBILLO S-90 P 70 m/m. FAC BOMBILLO S-90 P FAC BOMBILLO 301-RP 100 m/m. FAC CASQUILLO BOMBILLO 301-RP 120 m/m. FAC BOMBILLO 301-RP 90 m/m. FAC	CANDADOS DE ARCO NORMAL Y ARCO LARGO CANDADO DE 15 mm. / JMA FTH-12D / 698000142020 CANDADO DE 20 mm. / JMA / 698000143020 CANDADO DE 25 mm. / JMA FTH 13D / 698000144020 CANDADO DE 30 mm. / JMA YA 7D / 698000145020 CANDADO DE 40 mm. / JMA YA 7D / 698000146020 CANDADO DE 50-60-70 mm. / JMA U-5D/698000147020	690000052000 LLAVE EN BRUTO F CILINDRO PERFIL EUROPEO / JMA 22D CILINDROS F DE IMPORTACIÓN
CAJA 100-LL-PC CAJA 101-ISLL-P CAJA 101-SLL P CAJA 102-ISLL-P CAJA 104-SLL P CAJA ELEC. 100-E ADR CERRADURA SOB. MB PP CERRADURA SOB. MB-86 PP CERRADURA SOB. MBA PP CERRADURA SOB. MIBA PP CERRADURA SOB. S-90 AP B-50 / B-70 mm. CERRADURA SOB. S-90 CP B-50 / B-70 mm. CERRADURA SOB. S-90 P B-50 / B-70 mm.	690000125000 LLAVE BRUTO PULSADOR- CAUDALITA CAUDALITA PULSADOR B-1 CAUDALITA PULSADOR B-2 CAUDALITA PULSADOR B-3 CAUDALITA PULSADOR B-4	690000193000 LLAVE EN BRUTO P CILINDRO PERFIL EUROPEO LARGA / JMA 24 CILINDROS P DE IMPORTACIÓN
CERROJO 101-RP/105 CERROJO 301-LP/80 CERROJO 301-RP/80 CERROJO 301-RP/80 B-50 / 70 / 90 / 100 / 120 CERROJO 301-RP/80 TRANSPORT 50 / 70 / 90 / 100 / 120 CERROJO 301-RP/80 PUERTA BLINDADA CERROJO 305-RP/80 CERROJO 307-RP/80 B-50 / 70 mm. CERROJO 308-RP/80 B-50 / 70 mm. CERROJO EN PAREJA 304-F P/130 CILINDRO 70 mm. P 40x30 15 C/POMO CILINDRO 8067 70 mm. P 35x35 15 CAJA CILINDRO CDF 70 mm. P 35x35 15 CAJA CILINDRO CDF 80 mm. P 40x40 15 CAJA CONJ. SEGURIDAD CLONICO C/POMO 40x30 / LP CONJ. SEGURIDAD CLONICO CDF 35x35 / RP CONJ. SEGURIDAD CLONICO CDF 40x40 / RP CONJ. SEGURIDAD MC C/POMO 40x30 / LP CONJ. SEGURIDAD MC CDF 35x35 / RP CONJ. SEGURIDAD MC CDF 40x40 / RP CERROJO 946-RP/80 UVE CERROJO 446-RP/80 MAGNET UVE CERROJO 446-RP/80 B-70 mm. MAGNET UVE CERROJO 946-RP/80 B-70 mm. UVE SUBMOSTRADOR DE DEPÓSITO SMD 1C CERROJO 946-LP/80 UVE CERROJO 946-LP/80 B-70 mm UVE	690000153000 LLAVE EN BRUTO CERRADURA GARAJE VERTICAL / JMA CI-4D CERRADURA GARAJE VERTICAL	690000082000 LLAVE EN BRUTO F CILINDRO PRO / JMA KAE8D CILINDROS F PRO CILINDRO P RK CERROJO 946 RP/80 RK UVE CERROJO 946 RP/80 RK UVE 70 mm.
CERROJO 307-RP/80 B-50 / 70 mm. CERROJO 308-RP/80 B-50 / 70 mm. CERROJO EN PAREJA 304-F P/130 CILINDRO 70 mm. P 40x30 15 C/POMO CILINDRO 8067 70 mm. P 35x35 15 CAJA CILINDRO CDF 70 mm. P 35x35 15 CAJA CILINDRO CDF 80 mm. P 40x40 15 CAJA CONJ. SEGURIDAD CLONICO C/POMO 40x30 / LP CONJ. SEGURIDAD CLONICO CDF 35x35 / RP CONJ. SEGURIDAD CLONICO CDF 40x40 / RP CONJ. SEGURIDAD MC C/POMO 40x30 / LP CONJ. SEGURIDAD MC CDF 35x35 / RP CONJ. SEGURIDAD MC CDF 40x40 / RP CERROJO 946-RP/80 UVE CERROJO 446-RP/80 MAGNET UVE CERROJO 446-RP/80 B-70 mm. MAGNET UVE CERROJO 946-RP/80 B-70 mm. UVE SUBMOSTRADOR DE DEPÓSITO SMD 1C CERROJO 946-LP/80 UVE CERROJO 946-LP/80 B-70 mm UVE	690000160000 LLAVE EN BRUTO CERRADURA GARAJE HORIZONTAL / JMA AGA-7 CERRADURA GARAJE HORIZONTAL CERRADURA GARAJE HORIZONTAL DOBLE CERRADURA GARAJE HORIZONTAL PAREJA CERRADURA GARAJE HORIZONTAL C/PLEGADO	690000128000 LLAVE EN BRUTO PORTALLAVES ARMARIO PORTALLAVE K-20 ARMARIO PORTALLAVE K-40 ARMARIO PORTALLAVE K-80 ARMARIO PORTALLAVE K-105 ARMARIO PORTALLAVE K-140 ARMARIO PORTALLAVE K-240 CAUDALITA SUPER Nº 1 CAUDALITA SUPER Nº 2 CAJA PROFESIONAL EFECTIVO M-2
CONJ. SEGURIDAD CLONICO C/POMO 40x30 / LP CONJ. SEGURIDAD CLONICO CDF 35x35 / RP CONJ. SEGURIDAD CLONICO CDF 40x40 / RP CONJ. SEGURIDAD MC C/POMO 40x30 / LP CONJ. SEGURIDAD MC CDF 35x35 / RP CONJ. SEGURIDAD MC CDF 40x40 / RP CERROJO 946-RP/80 UVE CERROJO 446-RP/80 MAGNET UVE CERROJO 446-RP/80 B-70 mm. MAGNET UVE CERROJO 946-RP/80 B-70 mm. UVE SUBMOSTRADOR DE DEPÓSITO SMD 1C CERROJO 946-LP/80 UVE CERROJO 946-LP/80 B-70 mm UVE	690000135000 LLAVE EN BRUTO BUZON BUZON CANTABRICO BUZON ATLANTICO BUZON MEDITERRANEO CAJA PROFESIONAL EFECTIVO B-1	CILINDROS P PRO CILINDRO P RK CERROJO 946 RP/80 RK UVE CERROJO 946 RP/80 RK UVE 70 mm.
CERROJO 946-RP/80 UVE CERROJO 446-RP/80 MAGNET UVE CERROJO 446-RP/80 B-70 mm. MAGNET UVE CERROJO 946-RP/80 B-70 mm. UVE SUBMOSTRADOR DE DEPÓSITO SMD 1C CERROJO 946-LP/80 UVE CERROJO 946-LP/80 B-70 mm UVE	CANDADOS RECTANGULARES CANDADO DE 60 / JMA IS-16D CANDADO DE 70 Y 90 / JMA U-5D	690000126000 LLAVE EN BRUTO CAJA EMERGENCIA/CAUDALITA MINI CAUDALITA SUPER Nº 0 CAUDALITA SUPER Nº 3 CAUDALITA SUPER Nº 4 CAUDALITA MINI Nº 0 CAJA DE EMERGENCIA CAJA PROFESIONAL EFECTIVO M-1

LLAVES TALLADAS

llaves talladas			
	Utilización principal	Embalaje	Ref.
Caja mecánica	Caja LL-M-2000	(juego)	690010140000
Caja electrónica	Caja E	(juego)	690010141000
590-480 B	Cerradura 480-B	1	690000139000
Arca 70	Caja 100 mini	(juego)	692010122020
558 U.E. (Unión eléctrica)	Cerrojo 300 U.E.	(juego)	690010012020
571	Cerrojo 300-R	1	690010171020
577	Cerrojo 301-R	1	690010137020
586	Cerrojo 306-L B-70 mm	1	690010172020
587	Cerrojo 301-L	1	690010173020
L-70 mm	Cerrojo 301-L B-70 mm	1	690010174020
LS Niquelada	Cerrojo 101-L / 201-L / Cerradura S-90	1	690010165020
91-C Niquelada	Cerrojo 91-C / 50-R	1	690010164020
Plana	Cerrojo RP / LP / Cerrad. S-90 P / MB / MB 86 / MBA	1	690010195000
P Perfil Europeo	Cilindro Perfil Europeo (P)	1	690000053000
P Perfil Europeo C/Plástico	Cilindro Perfil Europeo (P)	1	690010152000
F Perfil Europeo	Cilindro Perfil Europeo (F)	1	690010175000
504 / S-90 P (S.T.S)	Cerradura 504 y S-90 P ant.	1	690000170000
MB-86 (S.T.S)	Cerradura MB-86 P	1	690000176000

AMAESTRAMIENTOS E IGUALAMIENTOS

amaestramientos

	Ref.
Grupo Sencillo llave "FAC"	99003
Grupo Maestra y Gran Maestra "FAC"	99005

igualamientos

	Ref.
Misma clave cilindro perfil europeo	99006
Con la misma llave "FAC"	99008
Con la misma llave "PLANA"	99009
Con la misma clave caja	99007
Con la misma clave cilindro RK	99010
Maletín Kit de Igualación FAC	99091
Maletín Kit de Igualación FAC/RP	99092
Maletín Kit de Igualación cilindros perfil europeo	99093
Maletín Kit de Igualación	

VARIOS

varios

	Ref.
Cortes llaves de caja	99100
Combinación caja mecánica	99101

Para la solicitud de estos servicios es necesario aportar la documentación pertinente (formulario e identificación).



desde 1931

FAC SEGURIDAD, S.A.

Polígono Industrial Monte Boyal
Avda. de la Constitución, parcelas 108/112
45950 Casarrubios del Monte
Toledo. ESPAÑA

Tel.: (34) 91 818 31 44

Fax: (34) 91 818 31 43

www.fac-seguridad.com

Servicio técnico

902 232 231



Nos reservamos el derecho de introducir cuantas modificaciones sean necesarias
para mejora de los artículos

All rights reserved to any deemed necessary to the improvement of our products

Reservamos o direito de modificar nos nossos artigos sem aviso prévio



fac-seguridad.com